

Errata

Title & Document Type: 53310A Modulation Domain Analyzer Operating Manual

Manual Part Number: 53310-90037

Revision Date: November 1992

HP References in this Manual

This manual may contain references to HP or Hewlett-Packard. Please note that Hewlett-Packard's former test and measurement, semiconductor products and chemical analysis businesses are now part of Agilent Technologies. We have made no changes to this manual copy. The HP XXXX referred to in this document is now the Agilent XXXX. For example, model number HP8648A is now model number Agilent 8648A.

About this Manual

We've added this manual to the Agilent website in an effort to help you support your product. This manual provides the best information we could find. It may be incomplete or contain dated information, and the scan quality may not be ideal. If we find a better copy in the future, we will add it to the Agilent website.

Support for Your Product

Agilent no longer sells or supports this product. You will find any other available product information on the Agilent Test & Measurement website:

www.tm.agilent.com

Search for the model number of this product, and the resulting product page will guide you to any available information. Our service centers may be able to perform calibration if no repair parts are needed, but no other support from Agilent is available.

HP 53310A

Modulation Domain Analyzer

MANUAL APPLICABILITY

This manual applies directly to an HP 53310A having a serial number prefix up to and including the one listed below. If the serial number prefix on your instrument is higher than the one shown below, refer to the "Manual Updating Changes" included with this manual.

For additional important information about serial numbers, see "Instruments Covered by This Manual" in the Introduction.

SERIAL NUMBER
Serial Number Prefix: 3121

Edition 1

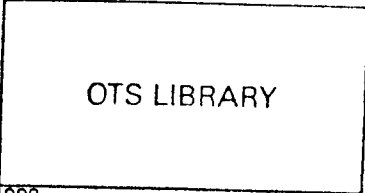

© Copyright HEWLETT-PACKARD COMPANY 1992
5301 STEVENS CREEK BOULEVARD, SANTA CLARA, CA 95052-8059

All rights reserved.

Printed NOVEMBER 1992

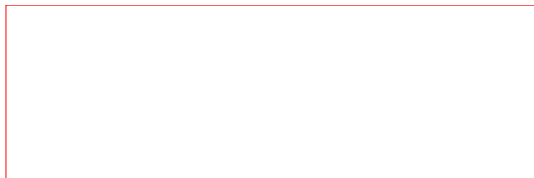

Safety Considerations

GENERAL

This product and related documentation must be reviewed for familiarization with safety markings and instructions before operation.

This product is a Safety Class I instrument (provided with a protective earth terminal).

BEFORE APPLYING POWER

Verify that the product is set to match the available line voltage and the correct fuse is installed. Refer to instructions in appendix A.

SAFETY EARTH GROUND

An uninterruptible safety earth ground must be provided from the mains power source to the product input wiring terminals or supplied power cable.

SAFETY SYMBOLS



Instruction manual symbol; the product will be marked with this symbol when it is necessary for the user to refer to the instruction manual.



Indicates hazardous voltages.



Indicates earth (ground) terminal.



Indicates terminal is connected to chassis when such connection is not apparent.



Alternating current.



Direct current.

WARNING

THIS DENOTES A HAZARD. IT CALLS ATTENTION TO A PROCEDURE, PRACTICE, OR THE LIKE, WHICH, IF NOT CORRECTLY PERFORMED OR ADHERED TO, COULD RESULT IN PERSONAL INJURY. DO NOT PROCEED BEYOND A *WARNING* SIGN UNTIL THE INDICATED CONDITIONS ARE FULLY UNDERSTOOD AND MET.

CAUTION

This denotes a hazard. It calls attention to an operating procedure, practice, or the like, which, if not correctly performed or adhered to, could result in damage to or destruction of part or all of the product. Do not proceed beyond a **CAUTION** sign until the indicated conditions are fully understood and met.

SAFETY INFORMATION

Warning

Any interruption of the protective grounding conductor (inside or outside the instrument) or disconnecting the protective earth terminal will cause a potential shock hazard that could result in personal injury. (Grounding one conductor of a two conductor outlet is not sufficient protection.)

Whenever it is likely that the protection has been impaired, the instrument must be made inoperative and be secured against any unintended operation.

If this instrument is to be energized via an autotransformer (for voltage reduction) make sure the common terminal is connected to the earthed pole terminal (neutral) of the power source.

Instructions for adjustments while covers are removed and for servicing are for use by service-trained personnel only. To avoid dangerous electric shock, do not perform such adjustments or servicing unless qualified to do so.

For continued protection against fire, replace the line fuse(s) only with 250V fuse(s) of the same current rating and type (for example, normal blow, time delay). Do not use repaired fuses or short circuited fuseholders.

When measuring power line signals, be extremely careful and always use a step-down isolation transformer whose output voltage is compatible with the input measurement capabilities of this product. This product's front and rear panels are typically at earth ground, so **NEVER TRY TO MEASURE AC POWER LINE SIGNALS WITHOUT AN ISOLATION TRANSFORMER.**

Regulatory Notice

**HP 53310A
Modulation Domain Analyzer**

ACCOUSTIC NOISE EMISSION:

LpA 47 dB at operator position, at normal operation, tested per ISO 7779. All data are the results from type test.

(German)

GERAeUSCHEMISSION:

LpA 47 dB am Arbeits platz, normaler Betrieb, geprueft nach DIN 45635 Teil 19. Die Angaben beruhen auf Ergebnissen von Typpruefungen.

Table of Contents

INTRODUCTION	HP 53310A Key Features	Introduction-1
	Manuals Supplied	Introduction-1
	Accessories Supplied	Introduction-2
	Accessories Available	Introduction-2
	Options Available	Introduction-2
	HP 53310A Specifications	Introduction-2
	Instruments Covered by this Manual	Introduction-3
Chapter 1	In This Chapter	1-1
FRONT PANEL	The Front Panel Organization	1-2
DESCRIPTION	The Display Area	1-4
	Selecting the Analyzer's Parameters	1-5
	System Control Keys	1-6
	Setup Keys	1-11
	Menu Keys	1-16
	Entry Keys	1-17
	Numeric Keypad	1-17
	Value Termination Keys	1-17
	Analysis Functions	1-19
	Enable Analysis	1-19
	Analysis Range	1-20
	Marker Tracking	1-20
	Std Dev (Shift, 0)	1-20
	Probability (Shift, .)	1-22
	Mean (Shift, 1)	1-22
	1/Mean (Shift, 2)	1-24
	Max (Shift, 4)	1-24
	Min (Shift, 7)	1-25
	Rate (Shift, 5)	1-26
	1/Rate (Shift, 6)	1-27
	Peak-Peak (Shift, 8)	1-27
	Clear Analysis (Shift, Clear)	1-28
	Inputs	1-29
	External Arm	1-29
	Channel A	1-29
	Channel B	1-30
	Channel C	1-30

Table of Contents

Chapter 2	In This Chapter	2-1
FUNCTION &	Function Menu	2-1
INPUT MENUS	Frequency	2-1
	Time Interval A→B	2-2
	Common/Separate	2-2
	Slope Setting	2-4
	+TI / ± TI	2-5
	Input Menu	2-7
	Voltage Threshold for Channels A, B, and C	
	(Option 030)	2-7
	External Arm Voltage Threshold	2-10
	External Arm Probe	2-11
	AC/DC Coupling	2-12
	Impedance	2-13
	Hysteresis	2-14
Chapter 3	In This Chapter	3-1
VERTICAL MENU	vs. Time or Histogram	3-1
	Center/Span	3-2
	Per Division	3-3
	Top/Bottom	3-4
	Max/Min	3-5
	Find Center	3-6
	Find Center and Span	3-6
	Frequency Function Display Limits	3-7
Chapter 4	In This Chapter	4-1
TIMEBASE MENU	Time/Div	4-1
	Reference	4-3
	Delay	4-5
	Panorama	4-7
	Window Timebase	4-10
	Window Position	4-11
	Time Aliasing	4-13
	Situations Where Time Aliasing May Occur	4-13
	Setting the Timebase Incorrectly	4-13
	Having a Signal with Extended Off-Time	4-14
Chapter 5	In This Chapter	5-1
TRIGGER MENU	Trigger Mode	5-1
	Trigger Condition	5-2
	Ext Edge Arming Mode	5-2

Table of Contents

	Ext Edge Slope	5-3
	Value Mode	5-3
	Value Slope	5-4
	Trigger HF Reject	5-4
Chapter 6	In This Chapter	6-1
DISPLAY MENU	vs. Time	6-2
	Display Background for vs. Time Mode	6-3
	Connect	6-4
	Repetitive or Real Time	6-4
	Real Time	6-5
	Single Persistence	6-5
	Infinite Persistence	6-5
	Repetitive	6-6
	Averaging Off/On	6-6
	Histogram	6-6
	Display Background for Histogram Mode	6-7
	Linear/Log	6-8
	Linear	6-8
	Log	6-8
	Y-Axis Scale	6-9
	Hist Accumulate	6-9
Chapter 7	In This Chapter	7-1
MARKERS MENU	Markers	7-1
	vs. Time Mode Markers	7-1
	Histogram Mode Markers	7-2
	Marker Tracking	7-3
	Analyze	7-4
Chapter 8	In This Chapter	8-1
HISTOGRAM	vs. Time	8-2
MENU	Hist From vs. Time	8-2
	Fast Histogram	8-3
	Data Display for Fast Histogram	8-3
	Acquire Start	8-4
	# Of Measurements	8-5
	Hist Accumulate	8-5
Chapter 9	In This Chapter	9-1
SAMPLING MENU	What is Sampling?	9-1
	A Frequency Sample	9-1
	A Time Interval Sample	9-1

Table of Contents

Maximum Sample Rate for Analyzer	
Measurement Modes	9-2
Maximum Measurement Rate for Frequency	
with Ext Arm or Time Sampling	9-2
Auto Sampling	9-4
Frequency vs. Time and Auto Sampling	9-4
Why Use Anything But Auto?	9-5
Frequency and Timebase Relationship	9-5
Situations Where You Would Want to	
Override Auto Sampling	9-6
Stability Measurement	9-6
Measurement Resolution versus	
Signal Dynamics	9-6
Frequency Sampling Modes	9-7
Interval At Center	9-7
What is Interval At Center?	9-8
Auto Sampling (with Auto Interval at Center)	9-8
Auto Sampling (with Manual Interval at Center)	9-8
Edge Sampling	9-9
Edge Sampling on Input Signal	9-10
Time Sampling	9-11
Frequency Sample Mode Examples	9-12
Frequency with Source Sampling	9-12
Frequency with Ext Arm Sampling	9-13
Frequency with Time Sampling	9-13
Time Interval and Auto Sampling	9-14
Time Interval Sampling Modes	9-14
Auto Sampling	9-14
Edge Sampling	9-15
Time Sampling	9-15
Time Interval Sample Mode Examples	9-16
+TI with Source A Sampling	9-16
+TI with Source B Sampling	9-17
+TI with Ext Arm Sampling	9-18
+TI with Time Sampling	9-19
±TI with Source A Sampling	9-20
±TI with Source B Sampling	9-21
±TI with Ext Arm Sampling	9-22
±TI with Time Sampling	9-23
Fast Sampling	9-24

Table of Contents

**Chapter 10
UTILITY MENU**

In This Chapter 10-1
Screen Saver 10-1
Clicker 10-2
HP-IB/Print Menu 10-2
 Talk Only Mode 10-2
 Addressed Mode 10-2
Form Feed 10-3
Paper Length 10-3
 Set Up Printer 10-3
Exit Menu 10-3
Self Cal Menu 10-4
Channel 10-4
Check 10-4
Start Calibration 10-4
 In Case of Failure 10-4
Exit Menu 10-5
Self Test Menu 10-5
Select What to Test 10-5
 All 10-5
 A1-1 10-5
 A1-2 10-5
 A2 10-6
 A3 10-6
 Miscellaneous 10-6
Loop 10-6
Start Test 10-7
Printout 10-7
 In Case of Failure 10-7

**Appendix A
INSTALLATION/
REAR PANEL**

In This Appendix A-1
Unpacking and Inspection A-1
Preparation for Use A-2
 Operating Temperature A-2
 Bench Operation A-2
 Power Requirements A-2
 Selecting Line Voltage A-3
 Checking for the Correct Fuse A-5
 Power Module Fuses A-5
 Oven Oscillator Fuse A-7
 Power Cable A-7
Hewlett-Packard Interface Bus (HP-IB) A-10

Table of Contents

	HP-IB Interconnections	A-10
	HP-IB Address Selection	A-11
	HP-IB Descriptions	A-11
	Rack Mounting Kits	A-14
	Storage and Shipment	A-14
	Environment	A-14
	Packaging	A-15
	Rear Panel	A-16
	HP-IB Connector	A-16
	Test Limit Output	A-16
	Reference Out	A-17
	External Reference In	A-17
	Oscillator Adjust	A-17
	Intensity Adjust	A-17
Appendix B	In This Appendix	B-1
STATUS	Status Messages	B-1
MESSAGES	acquiring data	B-1
	auto triggering	B-1
	no samples	B-1
	out of range	B-1
	POST failed	B-2
	pre-trigger	B-2
	running	B-2
	stopped	B-2
	triggered	B-2
	waiting for trigger	B-2
	Advisory Messages	B-3
	Autoscale FAILED	B-3
	Calibrating interpolators... FAILED.	B-3
	Calibrating interpolators... passed.	B-3
	Checking interpolator calibration... passed.	B-3
	Checking time axis	B-3
	Completing current meas.	
	Press STOP/SINGLE to abort.	B-3
	Data is limited by memory size.	B-4
	Display is limited by acquired data.	B-4
	Edge counts on Channel A must be	
	multiple of 2	B-4
	Finding 50% threshold on Channel A	B-4
	Finding 50% threshold on Channel B	B-4
	Finding signal	B-4

Table of Contents

Found better resolution B-4
 Frequency above selected maximum B-5
 Frequency span too large. Autoscale failed. B-5
 Frequency too low. Autoscale failed. B-5
 Frequency too low to adjust time axis B-5
 Grid lines are 1 decade apart,
 referenced to top B-5
 Hist mode changed from FAST to
 VS TIME mode B-5
 Limiting span B-6
 Little or no modulation found B-6
 Modulation rate too low to adjust time axis B-6
 No signal found on Chan A B-6
 No signal found on Chan B B-6
 Previous setup restored B-6
 print aborted not in talk only B-6
 SAMPLING by Ext edge is no
 longer selectable B-7
 Sampling interval may be multiple of
 selected value. B-7
 Seeking better resolution B-7
 Signal appears to drift. Try Autoscale again. B-7
 Span Includes Freqs Above Specification B-7
 Spurious modulation possible with this
 setup. B-8
 TIMEBASE : Not available in
 FAST HIST mode B-8
 Timebase setting too fast for this
 frequency range B-8
 Timebase setting too fast for sampling value ... B-8
 Too few intervals found. Autoscale failed. B-9
 TRIGGER : Not available in FAST HIST mode . B-9
 Unexpected value found by Autoscale routine .. B-9
 Using Auto Sampling to find signal B-9
 Vertical range > 7.75:1 Will clip
 bottom of screen B-9

**Appendix C
 SPECIFICATIONS**

Description C-1
 Function C-1
 Frequency C-1
 Time Interval C-1

Table of Contents

Input	C-1
Channels A and B	C-1
Channel C (Option 030)	C-1
External Arm	C-1
Vertical/Histogram Display Range	C-2
Timebase	C-2
Main Timebase	C-2
Window Timebase	C-2
Trigger	C-2
Trigger	C-2
Display	C-2
vs Time	C-2
Histogram	C-2
Markers	C-3
Histogram	C-3
Sampling Menu	C-3
Utility	C-3
HP-IB/Print set up	C-3
Autoscale	C-3
Automated Analysis	C-3
Save/Recall	C-3
Specifications and Characteristics	C-4
Frequency Measurements	C-4
Time Interval Measurements	C-7
Time Axis in vs Time	C-10
Inputs	C-10
Channel A and B	C-10
Channel C (Option 030)	C-10
External Arm	C-11
Frequency Reference	C-11
Option 010 High Stability Oven Reference ...	C-11
Rear Panel Connectors	C-11
Test Limit Output	C-12
Frequency Standard Input	C-12
Frequency Standard Output	C-12
Power Requirements	C-12
General	C-12
Spurious Frequency Modulation	C-13
Technical Explanation	C-13
Determining If Spurious Modulation May Occur	C-14
Example Computation	C-15

INTRODUCTION

The HP 53310A Modulation Domain Analyzer is a general purpose instrument for the analysis of modulation and jitter. It provides menu-driven front panel operation and full HP-IB programmability.

HP 53310A Key Features

The HP 53310A's key features include the following:

- Frequency and time interval measurement functions
- 8K measurements standard (32K measurements optional)
- Automatic measurements with the Autoscale feature
- Ability to trigger on a measurement value
- Automated functions for statistical analysis
- Fast update rate
- Single-shot or repetitive analysis
- Pre- and post-trigger viewing capability
- Save / Recall registers
- Printer output

Manuals Supplied

The documentation products included with your HP 53310A are:

- HP 53310A Quick Start Guide
- HP 53310A Operating Reference Manual
- HP 53310A Programming Quick Reference Guide
- HP 53310A Programming Reference Manual
- HP 53310A Service Manual

Accessories Supplied

The HP 53310A Modulation Domain Analyzer is supplied with the following accessory:

- Detachable Power Cable, 2.3 meters

The type of power cable supplied depends on the country of destination. Refer to *Table A-1, AC Power Cables Available*, for the part number of the appropriate cable.

Accessories Available

The following accessories are available for the HP 53310A:

- Soft Carrying Case (HP Part Number 1540-1066)
- Transit Case (HP Part Number 9211-1645)
- Service Accessories Kit (HP Part Number 53310-67001)
- Rack Mount Kit (HP Part Number 5061-6175)
- Rack Mount Slide Kit (HP Part Number 1494-0015)

Options Available

The following options are available for the HP 53310A:

- Option 001 Extended Measurement Memory (4X)
- Option 010 High Stability Oven Time Base
- Option 030 2.5 GHz Channel C
- Option 031 Digital RF Communications Analysis/High Resolution 2.5 GHz Input
- Option 910 Additional set of User Documentation (includes Quick Start Guide and Quick Start Signal Source)
- Option 915 Additional Service Manual
- Option 916 Additional set of User Documentation (excludes Quick Start Guide and Quick Start Signal Source)
- Option W30 Three-year customer return repair coverage
- Option W32 Three-year customer return calibration coverage

HP 53310A Specifications

HP 53310A Specifications

Instrument specifications are listed in appendix C, Specifications. These specifications are the performance standards or limits against which the instrument can be tested.

Instruments Covered by this Manual

This instrument has a two-part serial number in the form 0000A00000 which is stamped on the serial number plate attached to the rear of the instrument. The first four digits and the letter constitute the serial number prefix and the last five digits form the suffix. The prefix is the same for all identical instruments. It changes only when a change is made to the instrument. The suffix, however, is assigned sequentially and is different for each instrument. This manual applies directly to instruments having the same serial number prefix as listed under SERIAL NUMBER on the title page.

An instrument manufactured after the printing of this manual may have a serial number prefix that is not listed on the title page. These unlisted numbers indicate that the instrument is different from that documented in this manual. The manual for this newer instrument is accompanied by a "Manual Updating Changes" supplement. This supplement contains information that explains how to adapt the manual to the newer instrument.

In addition to change information, the supplement may contain information for correcting errors in the manual. To keep this manual as current and accurate as possible, Hewlett-Packard recommends that you periodically request the latest Manual Updating Changes. The supplement for this manual is identified with the manual print date and part number, both of which appear on the manual title page. Complimentary copies of the supplement are available from Hewlett-Packard. For information concerning a serial number prefix that is not listed on the title page or the Manual Changes supplement, contact your nearest Hewlett-Packard Sales and Support Office.

FRONT PANEL DESCRIPTION

In This Chapter

This chapter describes the function of all front-panel keys, with the exception of the menu keys. There is a separate chapter in this manual for each of the menus.

The controls and inputs for the HP 53310A Modulation Domain Analyzer are grouped into six areas on the front panel and this chapter follows the same organization:

- CRT (cathode ray tube) Display and Menu Softkeys.
- System Control keys.
- Setup keys.
- Menu keys.
- Entry keys.
- Input connectors.

The Front Panel Organization

The front panel is organized as follows:

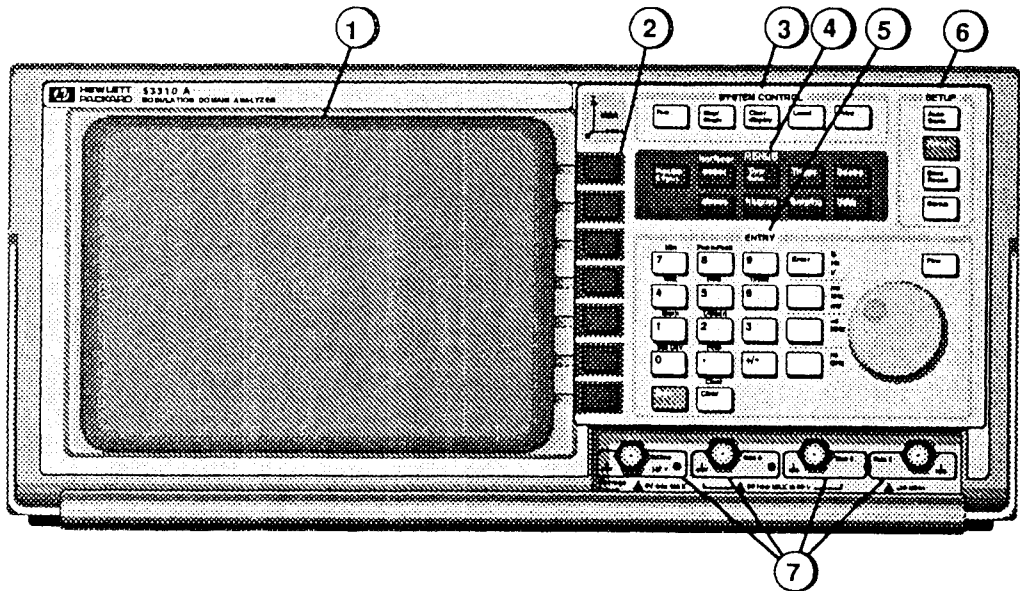

- ① The **CRT Display** shows the measurement data and the softkey choices for each of the menus.
- ② The **softkeys** are used to select the menu parameters displayed along the right edge of the CRT display.
- ③ The **SYSTEM CONTROL** keys command major functions of the Analyzer, including the starting and stopping of measurements.
- ④ The **MENU** keys provide access to all of the Analyzer parameters. These keys, along with the softkeys and numeric keys, let you set all instrument parameters.
- ⑤ The **ENTRY** keys are used for numeric entry and the selection of the analysis functions. The **knob** is used for marker control, and for modifying any softkey-selected numeric parameter.
- ⑥ The **SETUP** keys are a combination of controls to automatically set parameters, save and recall complete front-panel setups, and display a summary of Analyzer settings.
- ⑦ The **Input connectors** are the entry point for signals to be measured.

The Display Area

The Analyzer's display is partitioned into seven areas. The contents of each area is described on the next page.

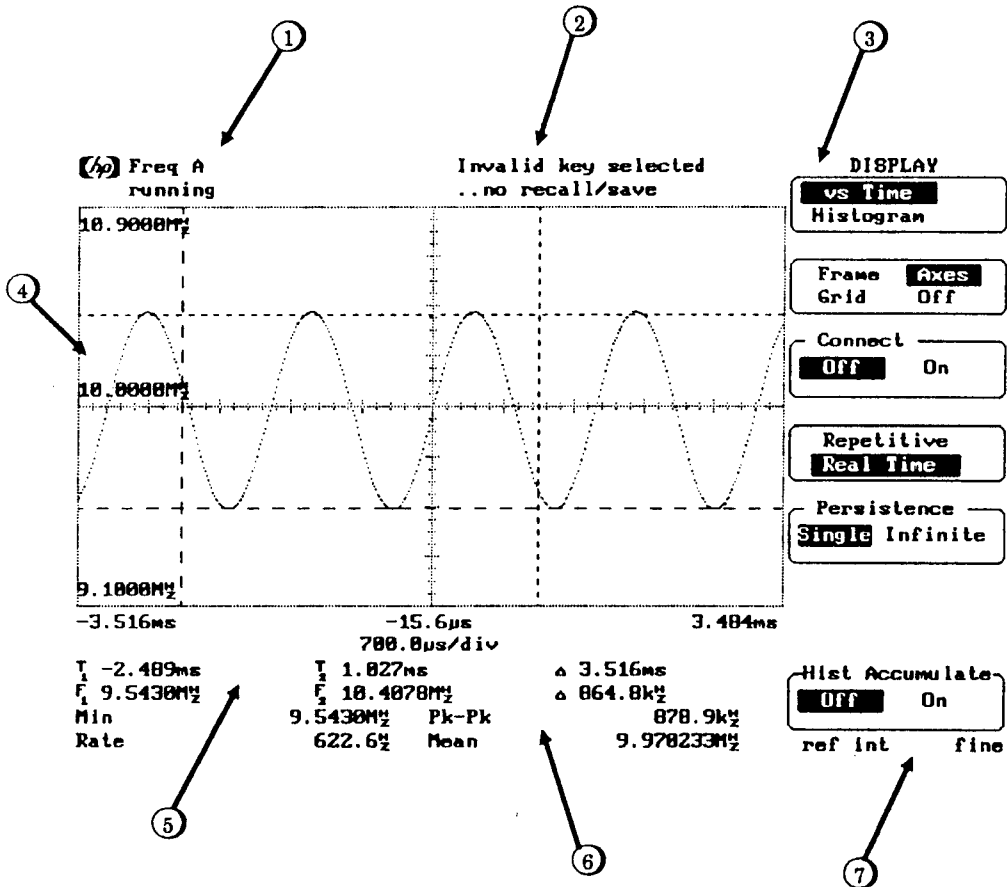

- ① Selected measurement function, HP-IB status, and Analyzer status.
- ② Advisory messages/HP-IB error messages.
- ③ Analyzer parameters. Parameters are modified as shown below. Pressing the **Status** key displays a summary of the Analyzer's settings here.
- ④ Display of data as a function of time ("vs. Time") or in a histogram (Hist From vs. Time or Fast Hist).
- ⑤ Marker and marker delta values.
- ⑥ Results of the analysis functions.
- ⑦ Status of the reference timebase and the **Fine** key On indication.

Selecting the Analyzer's Parameters

Selecting a menu and changing an Analyzer parameter is a simple process as shown below:

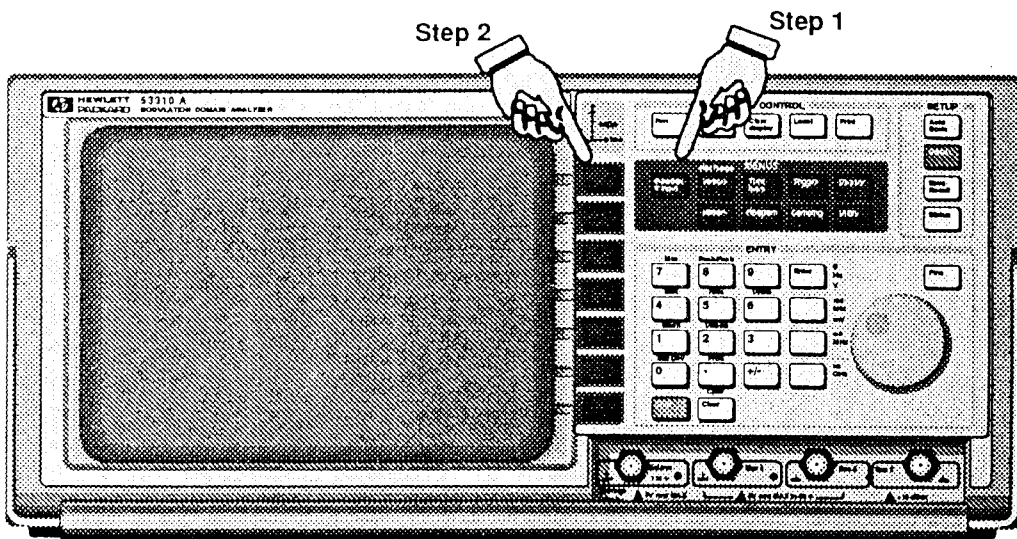

System Control Keys

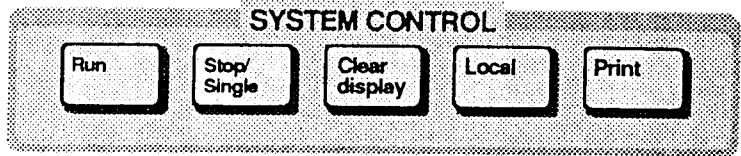

The System Control keys command major functions of the Analyzer. The general description below is followed by a detailed description of the keys on the next several pages:

- **Run and Stop/Single** — Start and stop data acquisition.
- **Clear display** — Erase measurement data from the “vs. Time” display or clear an accumulated histogram.
- **Local** — Restore local (front panel) control when the Analyzer is operating under remote control (unless **Local** key is locked out).
- **Print** — Copy display to a compatible graphics printer.



Use these two keys to control the acquisition status of the Analyzer. The **Run** key provides repetitive measurement acquisition; the **Stop/Single** key allows you to make single-shot acquisitions. The behavior of these two keys is summarized on the next page.

NOTE

The above summary assumes that all requirements for a measurement acquisition have been satisfied. These requirements include having an input signal(s) at the appropriate input(s) for the selected measurement setup and satisfying any trigger or sampling conditions that may be specified for data collection to occur. (Read the chapters on the Trigger and Sampling menus for more information.)

Operation of Run and Stop/Single Keys

CURRENT STATUS *	PRESS	DESCRIPTION	RESULTING STATUS
<i>running</i>	Stop/Single	Pressing the Stop/Single key while the Analyzer is in the <i>running</i> mode will cause the Analyzer to stop after the measurement acquisition in progress. If the Stop/Single key is pressed again with the measurement still in progress, the measurement acquisition is aborted.	<i>stopped</i>
<i>stopped</i>	Stop/Single	Pressing the Stop/Single key with the Analyzer in the <i>stopped</i> mode will cause the Analyzer to make a single acquisition and then stop.	<i>stopped</i>
<i>stopped</i>	Run	Pressing the Run key with the Analyzer in the <i>stopped</i> mode will cause the Analyzer to repetitively make measurement acquisitions.	<i>running</i>

* The Analyzer status appears near the upper left corner of the display.

System Control Keys



The **Clear display** key clears the display of all measurement data and analysis results. If the Analyzer is **stopped**, all data that is currently displayed will be erased. If the Analyzer is **running**, data will be erased, however, new data will be displayed after the next acquisition. Any data accumulated in a histogram will be cleared. The acquisition status of the Analyzer (running or stopped) is not affected.



A controller can be used to remotely operate the Analyzer over HP-IB. With the Analyzer in Remote, all front-panel keys are disabled, with the exception of the **Local** key. Pressing this key takes the Analyzer out of Remote and enables the front-panel keys. The **Local** key can also be disabled (locked out) by sending the *Local Lockout* command over HP-IB. When Local is locked out, you can return control to the front panel by sending a command over HP-IB. Refer to the *HP 53310A Programming Reference Manual* for more information.



Pressing the **Print** key copies the contents of the current display to a compatible graphics printer. All other operations of the Analyzer are stopped while data is being printed. The Analyzer must be set to "Talk Only" on the HP-IB/Print menu (accessed from the Utility menu). Addressed printing is possible over the HP-IB (refer to the *HP 53310A Programming Reference Manual*).

NOTE _____

Pressing any key while the printing is in progress will stop the printing.

Type of Printer

The Analyzer's print feature operates with HP graphics printers such as:

- HP 2225 ThinkJet printer
- HP 3630A PaintJet color graphics printer
- HP C1602A PaintJet XL color graphics printer

The graphics printer can have either an HP-IB interface or a Centronics parallel interface. The Analyzer has an HP-IB interface, so only an HP-IB cable is required for a connection to an HP-IB printer. If you have an HP PCL language graphics printer with a Centronics parallel interface, an adapter device is also required. The recommended device is the HP 92203J/K Microprint 45CH Interface Converter. The steps below demonstrate how to connect a printer to the Analyzer.

System Control Keys

Steps to Connect and Configure the Analyzer and Printer

1. Connect an HP-IB cable between the Analyzer and the HP-IB printer. (Remove any controller that is on the same HP-IB.)
2. If you have a Centronics parallel interface printer, connect the HP-IB cable to the HP-IB connector on the Microprint 45CH and the Centronics (parallel) cable from the printer to the Centronics connector on the Microprint 45CH.
3. Set the Analyzer to **Talk Only**.
 - a. Select the **Utility** menu.
 - b. Select the **HP-IB/Print** submenu.
 - c. Press the top softkey to highlight **Talk Only**.
4. Prepare the printer to receive data.

Consult the printer's operating manual to set the address switches to the listen mode on the HP-IB printer. If you are using a Centronics interface printer, set the Microprint 45CH to the Listen Only setting.

5. Switch the power to the HP-IB printer off and then on again after changing its address switches so it will recognize the new settings.
6. Press the **Print** key on the Analyzer.

The Analyzer will send a copy of the display to the printer. Once started, the printing can be stopped by pressing any front-panel key.

Setup Keys

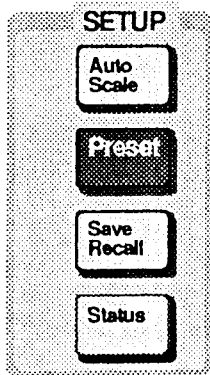

The Setup keys provide the following capabilities:

- Automatically evaluate input signals, acquire, and display measurement data.
- Set the Analyzer to a preset default state
- Save and Recall complete Analyzer setups
- Display a complete summary of Analyzer settings



The Autoscale feature automatically determines the vertical and horizontal scale settings for the display of your input signal data. You need only configure the Function and Input menus prior to using Autoscale.

Use Autoscale to have the Analyzer make the first attempt at setting parameters such as the vertical range and the time/div parameters. Then, you can fine tune these controls to display your signal data exactly as you want. When Autoscale is executed, the previous Analyzer setup will be stored in non-volatile memory. To retrieve that setup, press **Save/Recall** key, Recall Setup softkey, and 0.

Setup Keys

Before Using Autoscale

Before you use Autoscale, check the following items:

- Consider starting from the Preset condition. Although not necessary, this assures that the Analyzer is in a known state.
- You should configure the Function & Input menus as desired prior to using Autoscale, if they are not already appropriately configured.
- Your signal must be repetitive.

Conditions Preset by Autoscale

When the **Autoscale** key is pressed, the following conditions are preset:

- Analyzer set to Run mode.
- Delay and Window Position set to 0 on the Timebase menu.
- Auto trigger on a measured value is set on the Trigger menu.
- Sampling is set to Auto, except for \pm TI measurements where Edge sampling with an edge count of 1 is used.

Conditions Set by Autoscale

When the **Autoscale** key is pressed, the following conditions are set:

- Voltage threshold at 50% of the peak-to-peak voltage for the input signals being measured.
- Minimum and maximum display values for the signals being measured.
- Time/div value so that several cycles of the modulation results are displayed.

Autoscale Configurations

Autoscale can operate on the following Analyzer configurations:

- Frequency measurement at Channel A, B, or C (optional).
- Time Interval measurement, Channel A → B, Separate or Common inputs, +TI or ±TI.
- Acquisition mode: “vs. Time”, Hist From vs. Time, or Fast Hist.
- Value trigger set to: Auto Center or Manual on the Trigger menu.

If Autoscale Doesn't Work as Expected

If Autoscale fails, try pressing the **Preset** key and then press the **Autoscale** key again.

Autoscale does not execute a complete Preset of the Analyzer, but limits the changes to try and provide data for the current Analyzer configuration as much as possible. As a result, there could be some Analyzer settings that prevent Autoscale from successfully finding your signal.

Starting with the Preset condition is recommended whenever Autoscale fails to find your signal. Follow these steps:

1. Press the **Preset** key.
2. Configure the Function and Input menus as necessary for your particular situation.
3. Press the **Autoscale** key.



The green **Preset** key resets the Analyzer to default (known) conditions. Preset conditions are shown in *table 1-1*. The Analyzer setup prior to Preset is stored in Register 0. (See description of Save/Recall key below.)

Table 1-1. HP 53310A Preset Conditions

Function, Mode, or Value	Preset State
FUNCTION MENU Measurement Function Measurement Channel	Frequency A
INPUT MENU Voltage Threshold DC/AC Coupling Input Impedance Hysteresis	0.00 V DC 1 M Ω Minimum setting
VERTICAL MENU Center Span	100 MHz 50 MHz
TIMEBASE MENU time/div Reference Delay Panorama	100 μ s Center 0.00 s Off
TRIGGER MENU Trigger Mode Trigger Condition Frequency Value Value Slope Trigger HF Reject	Auto Frequency Value Auto Center (100 MHz) positive Off
DISPLAY MENU Display Mode Off/frame/axes/grid Connect Update Mode Persistence Histogram Accumulate	vs Time axes On Real Time Single Off
MARKERS MENU Time Markers Measurement Markers Analyze	Off Off All
HISTOGRAM MENU Display Mode	vs Time
SAMPLING MENU Sampling Mode Interval at Center	Auto Auto
UTILITY MENU Screen Saver Clicker	Off On

NOTE _____

The Analyzer automatically saves the current setup to Register 0 before executing an Autoscale, Recall, or Preset.



The **Save/Recall** key is used to gain access to the softkeys that let you save Analyzer setups or recall previously saved Analyzer setups from non-volatile memory. The setups in memory are preserved when the Analyzer is powered down or disconnected from a power source.

With a total of ten save/recall registers, there are nine registers available to you for save/recall operations. The Analyzer automatically saves the current setup to Register 0 before executing an Autoscale, Preset, or Recall function.



The **Status** key provides a complete summary of the Analyzer's settings. The information is organized by menu along the right edge of the display.

NOTE _____

Select this feature before printing if you want to include the setup information with the data captured on the display.

Menu Keys

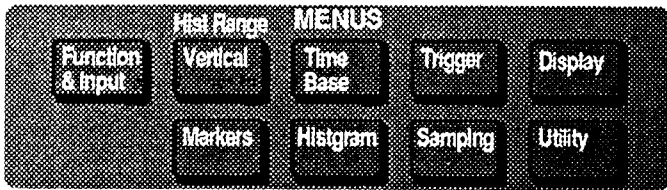

There are nine menu keys. The function of each menu is discussed in detail in its own chapter of this manual. The menus are listed here with a summary of what can be set on each menu. Refer to the appropriate chapter for detailed information on the menu of interest.

- ① **Function & Input menu** – Use this menu to configure the measurement function and input conditioning.
- ② **Vertical menu** – Use this menu to set the range for the measurement values to be collected and displayed.
- ③ **Timebase menu** – Use this menu to define the sweep time and the time-position of the data with respect to the sweep trigger.
- ④ **Trigger menu** – Use this menu to define how each measurement sweep should be triggered.
- ⑤ **Display menu** – Use this menu to modify the various characteristics of how acquired data is displayed.
- ⑥ **Markers menu** – Use this menu to control the markers.
- ⑦ **Histogram menu** – Use this menu to access the Fast Histogram mode.
- ⑧ **Sampling menu** – Use this menu to have manual control of the sampling for individual measurements within a measurement sweep.
- ⑨ **Utility menu** – Use this menu to set the HP-IB parameters, self-cal and self-test functions, screen saver feature, and clicker.

Entry Keys

The Entry area contains a numeric keypad, the value termination keys, the knob, and the **Fine** key.

Numeric Keypad

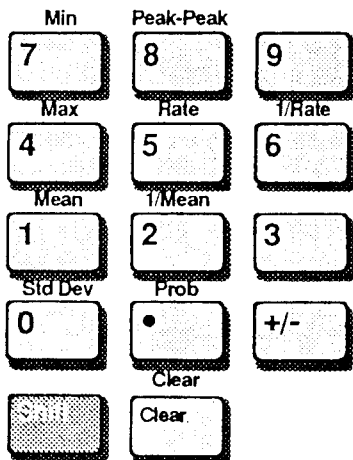

The numeric keypad is used to enter specific values into the numeric fields of the menu parameters. After entering a numeric value, press the key labeled with the desired units to terminate the entry.

Before you can enter a numeric value, the numeric field must be selected. Select a numeric field by pressing the softkey beside it. A field is selected when it is displayed in full-bright inverse video.

With the numeric keypad you can do the following:

- Use digits 0 to 9, and “.” (decimal point) to enter numeric values.
- Use the +/- key to toggle the numeric value from positive to negative, or negative to positive.

Value Termination Keys

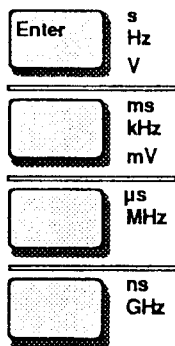

The value termination keys are located in a column beside the knob. The top key (Enter) is used to terminate the

entry of numbers without a multiplier. All the termination keys have multiple unit entry functions that include time, frequency, and voltage units. The scale of units that can be entered is described as follows:

- The time entry keys are labeled with the abbreviations for: seconds, milliseconds, microseconds, and nanoseconds.
- The frequency entry keys are labeled with the abbreviations for: Hertz, kilohertz, Megahertz, and Gigahertz.

Entry Keys

- The voltage entry keys are labeled with the abbreviations for: Volt and millivolt.
- For integer values, such as “# Of Measurements” under Fast Histogram on the Histogram menu, the multiplier keys can be used. For example, to enter 10,000: Press 1, 0, and the key below the one labeled “Enter.”



The blue **Shift** key is used to enable the analysis functions labeled in blue above the numeric keys. The procedure for enabling a function is to first press the blue key, and then press the numeric key below the function you want to enable. The analysis functions are described later in this chapter.

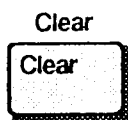

Use the **Clear** key to delete a numeric entry if you make an error entering a value into a numeric field. The previous value is restored.

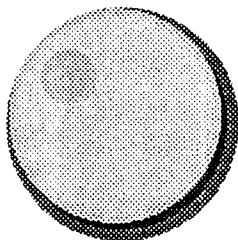

The knob can be used to change the value in any numeric field once the field is selected (it appears in full-bright inverse video). The knob is also used to modify the Hysteresis value.



The **Fine** key changes the increment and decrement resolution of the knob action for most numeric entry fields. Use Fine to make more precise settings of the numeric values with the knob. When the fine mode is selected, the word *fine* is displayed in the lower right corner of the display.

Analysis Functions

The Analyzer provides nine analysis functions for use on “vs. Time” or histogram data. The analysis results are displayed on the two lines at the bottom of the display (just below the marker readout lines). Up to four analysis results can be displayed at one time. Enabling a fifth function causes the first one selected to become inactive. Additionally, a function already enabled will move up to the first position if it is selected a second time.

Enable Analysis

To enable an analysis function, press the blue **Shift** key and then the desired analysis function as indicated in the following list:

- **Standard Deviation** (Shift, 0)
- **Probability** (Shift, .)
- **Mean** (Shift, 1)
- **1/Mean** (Shift, 2)
- **Maximum** (Shift, 4)
- **Rate** (Shift, 5)
- **1/Rate** (Shift, 6)
- **Minimum** (Shift, 7)
- **Peak-to-Peak** (Shift, 8)

All of the enabled analysis functions automatically re-execute each time new data is acquired or the display type is changed, for example, switching from “vs. Time” to histogram. Analysis functions are enabled individually, but they are disabled as a group with **Clear Analysis** (Shift, Clear) or by the Preset function.

NOTE

The display update rate is slowed by the analysis functions. For the fastest update rate, disable analysis functions.

Analysis Range

The analysis functions operate on the measurement values within the analysis range that is specified on the Markers menu. Your choices for the range of analysis are as follows:

- *Analyze All* includes the entire acquisition.
- *Analyze Between Markers* causes only the measurement values between the measurement markers to be included in the analysis.

Marker Tracking

Frequency or TI markers can be set to track the analysis results and indicate the results on the displayed data. Marker tracking is supported for only one analysis function at a time. When more than one analysis function is enabled, it is the last function enabled (in the upper left of the analysis area below the marker readouts) that will control the markers. If that analysis function does not support marker tracking, no tracking will be available, even if other enabled analysis functions do support marker tracking. The operation of marker tracking is described for each of the analysis functions below.

Std Dev (Shift, 0)



This function computes the standard deviation of the measurement values over the specified analysis range (set range with the Analyze softkey on the Markers menu). It operates on both “vs. Time” and histogram data, and on all measurement functions.

- For “vs. Time” data, the computed standard deviation is:

$$\left(\frac{1}{N} \sum_{i=1}^N (meas_i - mean)^2 \right)^{1/2}$$

where $meas_i$ is the i th frequency or time interval value, $mean$ is the computed mean of the measurements in the analysis range, and N is the total number of measurements in the analysis range.

- For histogram data, the computed standard deviation is:

$$\left(\frac{1}{N} \sum_{i=1}^N (meas_i - mean)^2 \times probability_i \right)^{1/2}$$

where $meas_i$ is the i th frequency or time interval value, $mean$ is the computed mean of the measurements in the analysis range, N is the total number of histogram bins in the analysis range, and $probability_i$ is the measured probability of occurrence at the corresponding $meas_i$.

As with the mean function for histogram measurements, standard deviation ignores any out of limit data when computing the result.

Marker Tracking and Standard Deviation

Once the standard deviation function is enabled and the the measurement axis markers are turned on, a marker tracking option is available. The marker movement with TRACK On (see Markers menu) is described below:

- “vs. Time” display

One Freq or TI marker moves to the mean plus one standard deviation; the other Freq or TI marker moves to the mean minus one standard deviation. Analyze All includes all the data in the display. If Analyze Between Markers is selected, you set the Time markers to delimit the range for analysis.

- Histogram display

If Analyze All is selected on the Markers menu, the measurement markers move plus and minus one standard deviation from the mean, as for “vs. Time”. If Analyze Between Markers is selected, the markers do not track. You set the Freq or TI markers to delimit the range for analysis.

Probability (Shift, .)



This function calculates the % of the measured data that falls within a given analysis range. It operates only on histogram data.

The computed probability is:

$$100 \times \sum_{i=1}^N \text{probability}_i$$

where probability_i is the measured probability at the i th frequency or time interval value, N is the total number of histogram bins in the analysis range. $i = 1$ refers to the first measurement value in the analysis range.

The probability function includes out of limit measurements. This allows detailed portions of a widely varying distribution to be measured while maintaining an indication of the contribution of the detailed portion to the total distribution.

Marker Tracking and Probability

There is no marker tracking for the Probability function.

Mean (Shift, 1)



This function computes the mean of the measurement values over the specified analysis range (set range with the Analyze softkey on the Markers menu). It operates on both "vs. Time" and histogram data, and on all measurement functions.

- For "vs. Time" data, the computed mean is:

$$\frac{1}{N} \sum_{i=1}^N \text{meas}_i$$

where N is the number of samples in the analysis range and meas_1 is the first sample in that range. In this case,

$meas_i$ refers to either time interval data or frequency data, depending on the selected measurement function.

- For histogram data, the computed mean is:

$$\sum_{i=1}^N meas_i \times probability_i$$

where N is the number of histogram bins in the analysis range, each $meas_i$ is a frequency or time interval value, depending on the selected measurement function. $meas_1$ is the first frequency or time interval in the analysis range. $probability_i$ is the measured probability of occurrence at the corresponding $meas_i$. Out of limit results are ignored in this computation.

Marker Tracking and Mean

Once mean is enabled and the measurement axis markers are turned on, a marker tracking option is available. The marker movement with TRACK On (see Markers menu) is described below:

- “vs. Time” display

One Freq or TI marker moves to the mean. Analyze All includes all the data in the display. If Analyze Between Markers is selected, you set the Time markers to delimit the range for analysis.

- Histogram display

If Analyze All is selected on the Markers menu, one of the Freq or TI markers moves to the mean. If Analyze Between Markers is selected, the marker does not track. You set the Freq or TI markers to delimit the range for analysis.

1/Mean (Shift, 2)



This function operates on both “vs. Time” and histogram data, and on all measurement functions. In all cases, the result is the inverse of the result obtained with the mean function. For a constant frequency input, this function would be useful for obtaining an estimate of the average period of your input.

Max (Shift, 4)



This function operates on both “vs. Time” and histogram data, and on all measurement functions. In all cases, the result is the largest value on the measurement axis within the specified analysis range (set range with the Analyze softkey on the Markers menu).

***Marker Tracking
and Max***

Once maximum is enabled, and the the measurement axis markers are turned on, a marker tracking option is available. The marker movement with TRACK On (see Markers menu) is described below:

- “vs. Time” display

One Freq or TI marker moves to the maximum value within the specified analysis range. Analyze All includes all the data in the display. If Analyze Between Markers is selected, you set the Time markers to delimit the range for analysis.

- Histogram display

If Analyze All is selected on the Markers menu, one of the Freq or TI markers moves to the maximum value. If Analyze Between Markers is selected, the marker does not track. You set the Freq or TI markers to delimit the range for analysis.

Min (Shift, 7)



This function operates on both “vs. Time” and histogram data, and on all measurement functions. In all cases, the result is the smallest value on the measurement axis within the specified analysis range (set range with the Analyze softkey on the Markers menu).

***Marker Tracking
and Min***

Once minimum is enabled, and the the measurement axis markers are turned on, a marker tracking option is available. The marker movement with TRACK On (see Markers menu) is described below:

- “vs. Time” display

One Freq or TI marker moves to the minimum value within the specified analysis range. Analyze All includes all the data in the display. If Analyze Between Markers is selected, you set the Time markers to delimit the range for analysis.

- Histogram display

If Analyze All is selected on the Markers menu, one of the Freq or TI markers moves to the minimum value. If Analyze Between Markers is selected, the marker does not track. You set the Freq or TI markers to delimit the range for analysis.

Rate (Shift, 5)



This function operates only on “vs. Time” data, and on all measurement functions. It is useful for measuring the rate at which a particular modulation is occurring.

The method used to compute the rate is as follows:

This function obtains a result by first establishing a threshold crossing level. The selected value is:

$$\text{threshold level} = \frac{\text{meas}_{\max} + \text{meas}_{\min}}{2}$$

where the meas_{\min} and meas_{\max} are selected from the specified analysis range. In other words, the threshold crossing level is halfway between the peak measurements within the analysis range.

Having established the threshold level, the signal is scanned (within the analysis range) for crossings of the threshold, starting at the left edge of the analysis range (smallest time value). If the first crossing has a positive slope, then only positive-slope crossings are counted thereafter. Similarly, if the first crossing has a negative slope, then only negative-slope crossings are counted. The number of crossings in the analysis region are totaled, and if there are more than two, the following result is computed:

$$\text{modulation rate} = \frac{\text{number of crossings} - 1}{\text{time}_{\text{last cross}} - \text{time}_{\text{first cross}}}$$

The numerator defines the number of periods that were detected, the denominator the time over which the integral number of periods occurred. The crossing time is determined by interpolating from data that spans the crossing to estimate the time when the signal crossed the threshold. To avoid extra counting of crossings on noisy modulations, there is hysteresis built-in to the counting detection algorithms. The amount of hysteresis is about 10% of the peak-to-peak modulation level. If fewer than two crossings are detected, no modulation rate result is produced.

**Marker Tracking
and Rate**

Once modulation rate is enabled and the measurement axis markers are turned on, a marker tracking option is available. The marker movement with TRACK On (see Markers menu) is described below:

- “vs. Time” display

One Freq or TI marker moves to the crossing level used to evaluate the modulation rate. Analyze All includes all the data in the display. If Analyze Between Markers is selected, you set the Time markers to delimit the range for analysis.

1/Rate (Shift, 6)



This function operates only on “vs. Time” data, and on all measurement functions. In all cases, the result is the inverse of the result obtained with the rate function. This function is useful when an indication of the period of the modulation is desired.

Peak-Peak (Shift, 8)

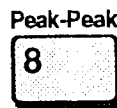

This function operates on both “vs. Time” and histogram data, and on all measurement functions. In all cases, the result is the positive difference between the largest value and smallest value on the measurement axis (within the specified analysis range).

**Marker Tracking and
Peak-Peak**

Once the peak-peak function is enabled and the measurement axis markers are turned on, a marker tracking option is available. The marker movement with TRACK On (see Markers menu) is described below:

- “vs. Time” display

One Freq or TI marker moves to the positive peak; the other Freq or TI marker moves to the negative peak of the data. Analyze All includes all the data in the display. If Analyze Between Markers is selected, you set the Time markers to delimit the range for analysis.

Analysis Functions

- Histogram display

If Analyze All is selected on the Markers menu, one measurement marker moves to the positive peak value; the other measurement marker moves to the negative peak value. If Analyze Between Markers is selected, the markers do not track. You set the measurement markers to delimit the range for analysis.

Clear Analysis (Shift, Clear)

Use this feature to turn off the enabled analysis functions. Press the blue **Shift** key and then press the **Clear** key.

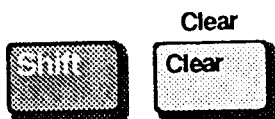

Inputs

The standard front-panel inputs are External Arm, Channel A and B. Channel C, providing an extended frequency range, is available as an option (Option 030).

There are input trigger lights (green LEDs) near each input connector. They indicate input status. The operation of the lights is explained in chapter 2 under "Operation of Input Trigger Lights."

External Arm

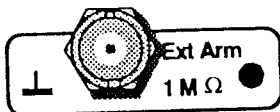

Range: dc coupled to 100 MHz

Impedance: 1 MΩ (nominal)

Damage Level: 5 V rms

A full description of the External Arm input characteristics can be found in appendix C, "Specifications."

Channel A

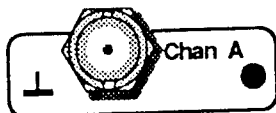

Range: 10 Hz to 200 MHz

Damage Level: 50Ω — 5 V rms (ac + dc)
 1 MΩ — < 5 kHz = 40 V rms
 > 5 kHz = 5 V rms

A full description of the Channel A input characteristics can be found in appendix C, "Specifications."

Inputs

Channel B

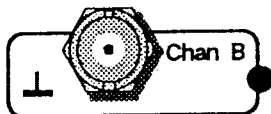

Range: 10 Hz to 100 MHz

Damage Level: 50Ω — 5 V rms (ac + dc)
 $1\text{ M}\Omega$ — $< 5\text{ kHz} = 40\text{ V rms}$
 $> 5\text{ kHz} = 5\text{ V rms}$

A full description of the Channel B input characteristics can be found in appendix C, "Specifications."

Channel C

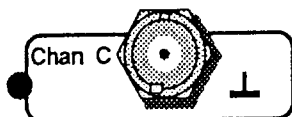

The Channel C option 030 extends the frequency range of the HP 53310A to 2.5 GHz.*

Range: 50 MHz to 2.5 GHz

Trigger Level: 0 V on a positive slope

Input Impedance: ac coupled, 50Ω

Damage Level: +15 dBm

A full description of the Channel C input characteristics can be found in appendix C, "Specifications."

* The Channel C option 031 is described in the Option 031 User's Guide. The guide contains operating, programming, and specification information.

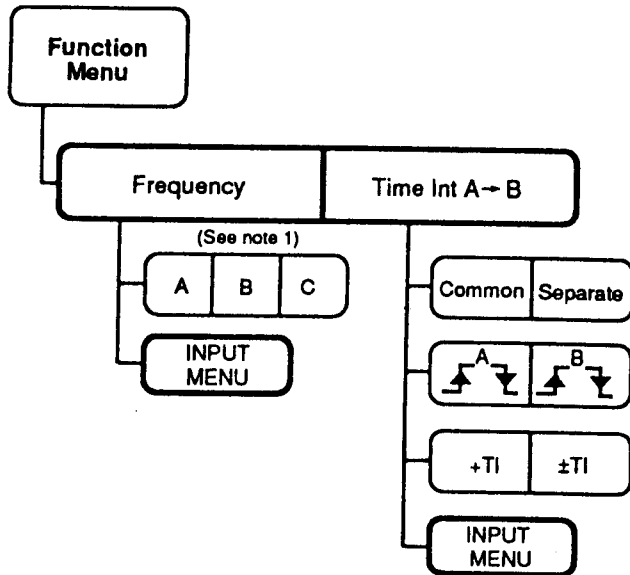

Note

1. Channel C appears only when Option 030 C channel is installed.

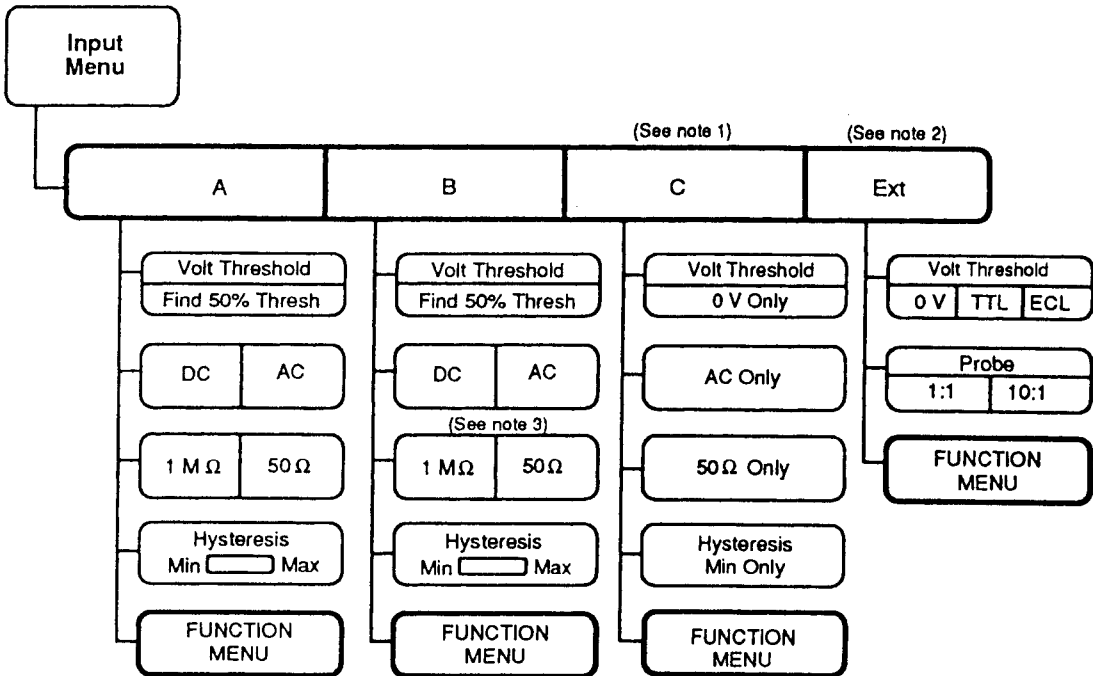

Notes

1. Channel C appears only when Option 030 C channel is installed.
2. An external signal can be used to control when the Analyzer acquires data. Refer to the Trigger, Sampling, and Histogram menus.
3. When Time Int A→B, Common is selected, channel B impedance is automatically set the same as for channel A

FUNCTION & INPUT MENUS

In This Chapter

The Function & Input menus let you set the following:

- Type of measurement.
- Measurement channel or channels.
- The conditioning available for the input signals.

This chapter describes each of the parameters available on these menus and how to use them.

Function Menu

Use the Function menu to select the type of measurement you want to make.

Frequency

Single-channel frequency measurements can be made on channels A, B, or C (Option 030). The range of frequency measurement for each channel is as follows:

- Channel A measures 10 Hz to 200 MHz.
- Channel B measures 10 Hz to 100 MHz.
- Channel C (Option 030) measures 50 MHz to 2.5 GHz.

Related Programming Commands

`[[:SENSE]:]FUNCTION`

Function Menu

Time Interval A→B

Time interval measurements can be made on the A and B input channels. The range of time interval measurements is as follows:

- +TI measures intervals from 20 ns to 1 second.
- ± TI measures intervals from -0.5 s to +0.5 s.

Related Programming Commands

[[:SENSE]:]FUNCTION

Common/Separate

When making time interval measurements, the A and B input channels can be set to **Common** or **Separate**. Use **Common** to make time interval measurements on the events occurring on channel A. Use **Separate** to measure time intervals between the events on channel A and the events on channel B. See the description below of +TI / ± TI for how time interval measurements operate.

The **Common** setting makes single-channel time interval measurements possible. *Figure 2-1* illustrates how **Common** works.

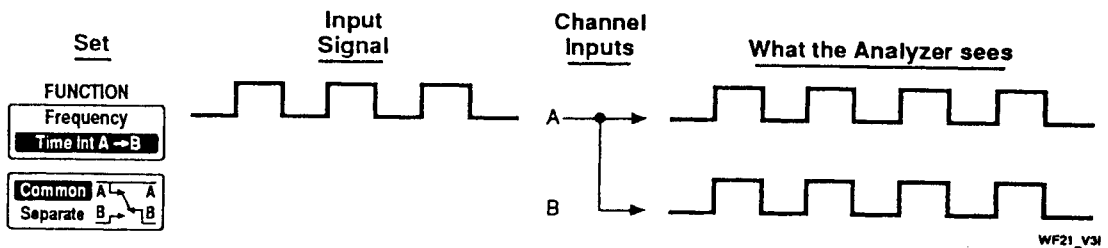

Figure 2-1. Time Interval A→B with Common Inputs

The **Separate** input setting makes possible time interval measurements between the signals at channel A and channel B as shown in *figure 2-2*.

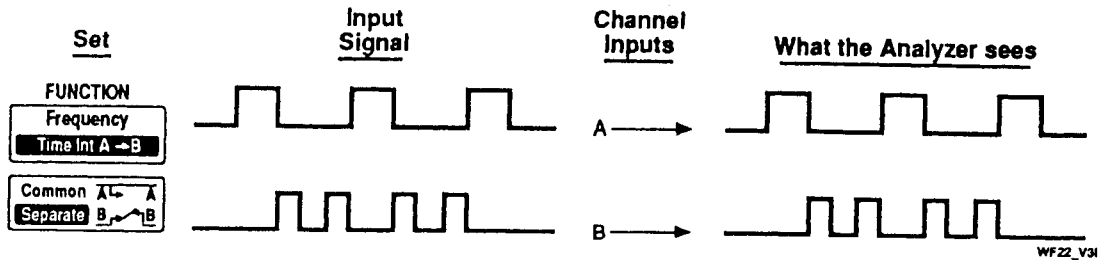

Figure 2-2. Time Interval A→B with Separate Inputs

Comments Common/Separate preset = Separate

When set to Common, the channel B input is loaded with the impedance specified for the channel A input. The input impedance is reduced to 500 kΩ with the 1 MΩ setting in the Common mode, but remains 50Ω when using the 50Ω setting. There are still separate channel B settings for the voltage threshold, ac/dc coupling, and hysteresis parameters. (See the Input menu description for more information.)

Related Features Slope Setting
+TI
± TI

Related Programming Commands [:SENSE]:TINterval:ROUTE

Slope Setting

The slope field uses a graphic representation of rising and falling edges to let you select the slopes of the input signals upon which to make time interval measurements.

Figure 2-3 shows the slope controls set to measure from a rising edge on channel A to a falling edge on channel B. With the inputs set to Common, this would produce a positive pulse width measurement.

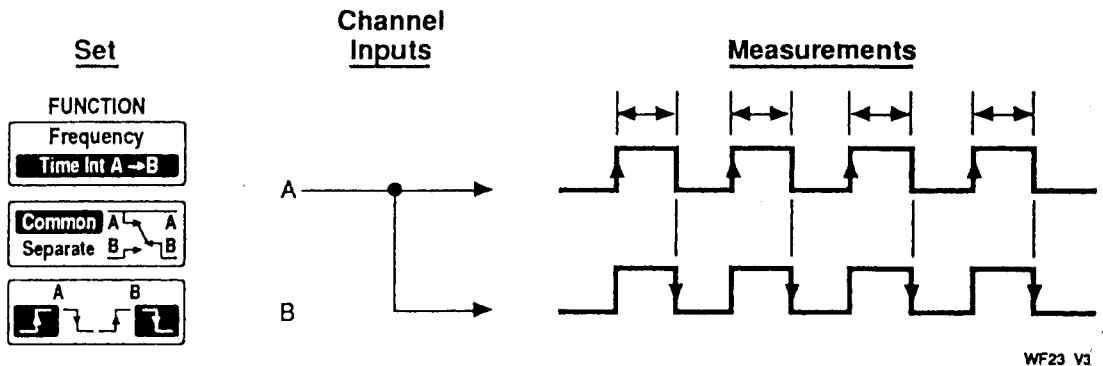

Figure 2-3. Time Interval A→B, Common Inputs, with Slope Controls Set for a Positive Pulse Width Measurement

Comments Slope Setting preset = rising slope on A, rising slope on B

Related Features Common/Separate
+TI
± TI

Related Programming Commands [:SENSE]:TINTerval:SLOPe

+TI / \pm TI

In all cases, +TI makes time interval measurements that start on channel A and stop on channel B. For +TI, the specified minimum time between a start edge and a stop edge is 20 ns, while \pm TI can measure a result of 0 seconds between the start and stop edges.

\pm TI allows time interval measurements to start on either channel A or B, but the result is always reported as the time (possibly negative) from A to B. The start channel is determined by the first event to occur on either channel after the Analyzer is ready to begin measuring.

+TI measurements will always start on channel A. *Figure 2-4* shows a +TI A \rightarrow B measurement with separate inputs.

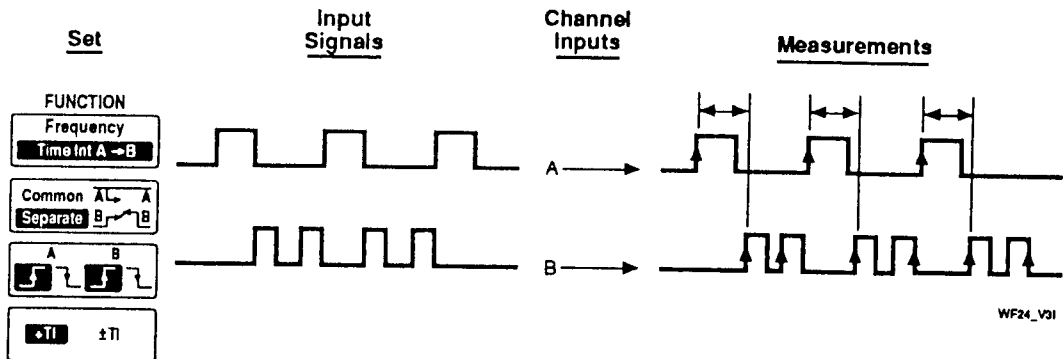

Figure 2-4. +TI A \rightarrow B with Separate Inputs

With \pm TI measurements, the first channel may be either A or B, depending on which channel first provides an appropriate edge when the Analyzer is ready to measure. Measurements may start on channel B, stop on channel A and vice versa, but the result is always reported as the time from A to B. *Figure 2-5* shows \pm TI A \rightarrow B measurements that start and stop on both input channels. This example uses the same signals as *figure 2-4*.

Function Menu

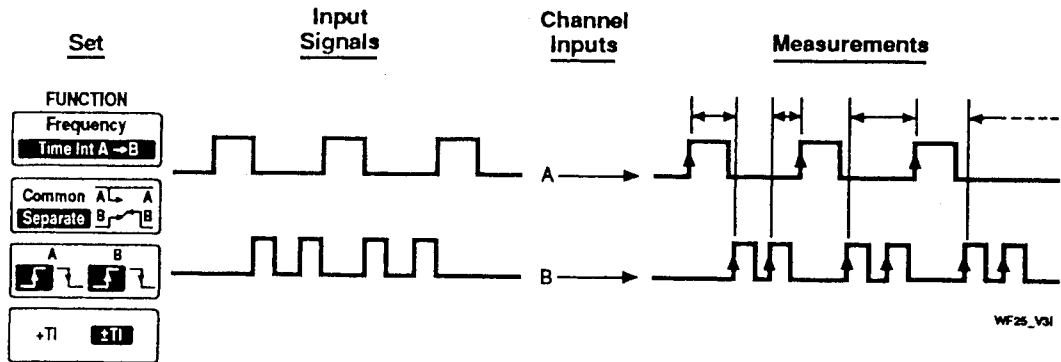

Figure 2-5. \pm TI A→B with Separate Inputs

Comments $+TI / \pm TI$ preset = $+TI$

Use $+TI$ when you know the order in which the edges on the input signals are occurring and you always want to start your measurements on the same channel. The minimum specified interval that $+TI$ can measure is 20 ns, so use $\pm TI$ if the interval to be measured is less than 20 ns, or if the order of occurrence of your signal edges varies. $+TI$ measurement results will always be positive. $\pm TI$ measurements can be positive or negative, depending on whether the measurement starts on channel A (positive result) or channel B (negative result).

Related Features Common/Separate
Slope Setting

Related Programming Commands [:SENSe]:TINterval:TYPE

Input Menu

Use the Input menu to condition the Analyzer inputs for your signals.

Once the Analyzer is properly sensing an input signal (indicated by a flashing LED at the Analyzer's input connector), you can prepare to make measurements. The Input menu provides controls to do the following:

- Specify a voltage threshold.
- Select ac or dc coupling.
- Set a high or low input impedance.
- Set hysteresis to ensure correct counting on noisy or low frequency signals.

Voltage Threshold for Channels A, B, and C (Option 030)

The threshold feature provides you with two ways to set the voltage level at which the Analyzer will detect your input signal. One method lets you enter a voltage value directly, while the other will perform an automatic search for the 50% peak-to-peak voltage value of the input signal and set that value as the threshold.

Example

Set voltage threshold manually

You can manually set a voltage threshold by following these steps:

1. Press the **Volt Threshold** softkey to select the numeric field.
2. Use the Entry keypad to enter your voltage value.
3. Terminate your entry with one of the voltage termination keys.

Set voltage threshold automatically

You can have the Analyzer automatically find the 50% peak-to-peak voltage threshold of your input signal by pressing the **Find 50% Thresh** softkey. The Autoscale feature automatically sets the voltage threshold for the input signals.

NOTE

The approximate 50% voltage point is determined once when the Find Threshold key is pressed. The threshold must be set again should the peak signal voltages change.

The Find Threshold function does not operate on input signals less than 40 Hz.

Comments **Voltage Threshold preset = 0 V**

The voltage threshold setting is closely related to the Hysteresis parameter described later in this chapter. If you need to know more about how your input signal is detected by the Analyzer, read about hysteresis at this time.

Related Features Coupling
 Impedance
 Hysteresis

Related Programming [:SENSE]:EVENT:LEVEL
Commands [:SENSE]:EVENT:LEVEL:AUTO ONCE

***Operation of Input
Trigger Lights***

There are three green LEDs near the front-panel input connectors that indicate if signals are being detected by the Analyzer. These trigger lights are used to tell when an input signal is crossing the voltage threshold properly, and therefore ready to be measured.

- The trigger lights have three operation states: off, on, and flashing.

Off indicates the input signal level is below the current voltage threshold.

On indicates the input signal is above the current voltage threshold.

Flashing indicates the input signal is repetitively crossing the voltage threshold. For low input frequencies, the flashing rate is indicative of the rate at which the voltage threshold is being crossed.

- Channel B and Channel C (Option 030) share a trigger light.

The shared light indicates the status of channel B, except when Frequency on channel C is selected. When Frequency C is selected, a flashing light indicates that an input signal is being detected, but when an input signal is not present, the light may remain either on or off.

**External Arm
Voltage Threshold**

A signal connected to the External Arm input can be used for following tasks:

- As a trigger signal causing the Analyzer to capture and display measurement data (see Trigger menu).
- As a signal telling the Analyzer when to capture samples for Frequency measurements (see Sampling menu).
- As a signal causing the Analyzer to start acquiring data into the Fast Histogram (see Histogram menu).

When setting the voltage threshold for an external arm signal, the choices are pre-defined. There are three choices for the threshold value. Your choice is determined by the characteristics of your external arm signal as described in the following list:

- 0V threshold for most signals.
- TTL threshold of 1.5 V (nominal) for TTL circuits.
- ECL threshold of -1.3 V (nominal) for ECL circuits.

Comments

External Arm Voltage Threshold preset = TTL

*Related Programming
Commands*

TRIGger:LEVel

External Arm Probe

The Probe parameter is used with the External Arm TTL or ECL threshold settings. The 1:1 setting has no effect on the voltage threshold, while the 10:1 setting reduces by a factor of 10 the signal voltage required for detection by the Analyzer as described below.

The 10:1 probe setting for the External Arm signal behaves as follows:

- **TTL and 10:1** provides a threshold setting at the Analyzer input of 0.15 V (nominal) for TTL circuits.
- **ECL and 10:1** provides a threshold setting at the Analyzer input of -0.13 V (nominal) for ECL circuits.

Comments

External Arm Probe preset = 1:1

When the 10:1 Probe value is selected, the voltage level that will be detected by the Analyzer is still 1.5 V for TTL and -1.3 V for ECL at the 10:1 probe tip.

Related Programming Commands

TRIGger:LEVel

AC/DC Coupling

The coupling parameter lets you select either ac or dc coupling for the A and B input channels. Only ac coupling is available for the optional channel C input.

The input signal coupling can affect whether the input signal is detected by the Analyzer. The effect of ac and dc coupling on an input signal is shown in *figure 2-6*.

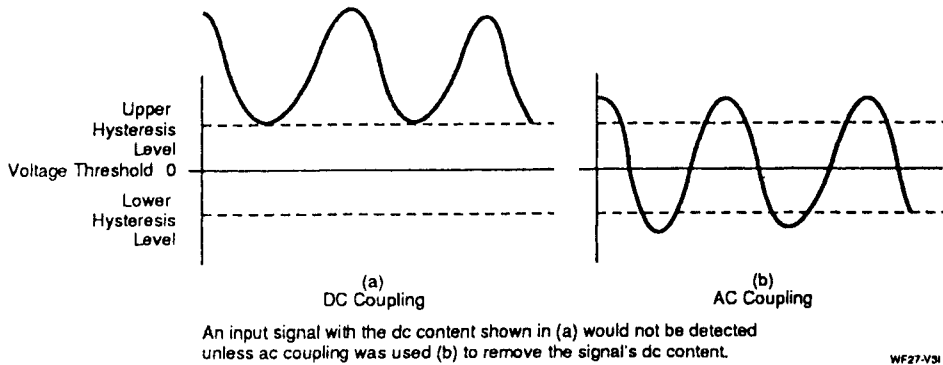

Figure 2-6. DC and AC Coupling on an Input Signal

Comments AC/DC Coupling preset = DC

DC coupling is recommended for time interval measurements where detection by the Analyzer is generally required at a specific voltage on the input waveform. AC coupling can be used to remove the dc content of an input signal with a dc offset, however, the detection point changes with duty cycle when using ac coupling.

Related Features Voltage Threshold
Impedance
Hysteresis

Related Programming Commands :INPut:COUPling

Impedance The impedance field provides two choices of input impedance for the A and B input channels, 1 M Ω or 50 Ω . Only a 50 Ω input impedance is available for the optional channel C input.

Comments Impedance preset = 1 M Ω

For frequencies up to 10 MHz, a 1 M Ω input impedance is usually preferred. With this impedance level, the majority of sources connected to the input are not loaded down. Beyond about 10 MHz, the inherent shunt capacitance of high impedance inputs rapidly reduces input impedance. It is at the higher frequencies where the 50 Ω impedance level, with lower shunt capacitance, is preferred.

When making Time Int A \rightarrow B measurements with Common inputs, the input impedance is reduced to 500 k Ω with the 1 M Ω setting but remains 50 Ω when using the 50 Ω setting.

NOTE _____

In 50 Ω systems with fast rise/fall time signals, the 50 Ω setting is preferred to reduce reflections and ringing that may cause multiple threshold crossings (even if the fundamental frequency is low).

Related Features Voltage Threshold
Coupling
Hysteresis

Related Programming Commands :INPut:IMPedance

Hysteresis

For a signal transition to be detected by the Analyzer, the input signal must cross through the *hysteresis band*. The band has an upper and lower limit. The transition through the band activates the voltage threshold detection circuit.

The voltage difference between the two levels, called *hysteresis limits*, defines the hysteresis band of the detection circuit.

The Hysteresis parameter can be used to increase the noise immunity of the Channel A and B inputs. If the Analyzer is miscounting an input signal, it could be the result of noise on the input signal. This feature allows you to select a level of hysteresis that will make the input circuitry less susceptible to counting the noise of an input signal. See the example on the next page.

Example of Hysteresis

Hysteresis can be set from a minimum to a maximum. Minimum hysteresis is the default value and provides the most sensitive input setting. There are ten steps between the minimum and maximum setting. Moving towards the maximum setting widens the hysteresis band making it more difficult for a noisy input signal to cause a miscount. However, maximum hysteresis provides the worst sensitivity. *Figure 2-7* shows this concept of minimum and maximum hysteresis settings on a noisy signal.

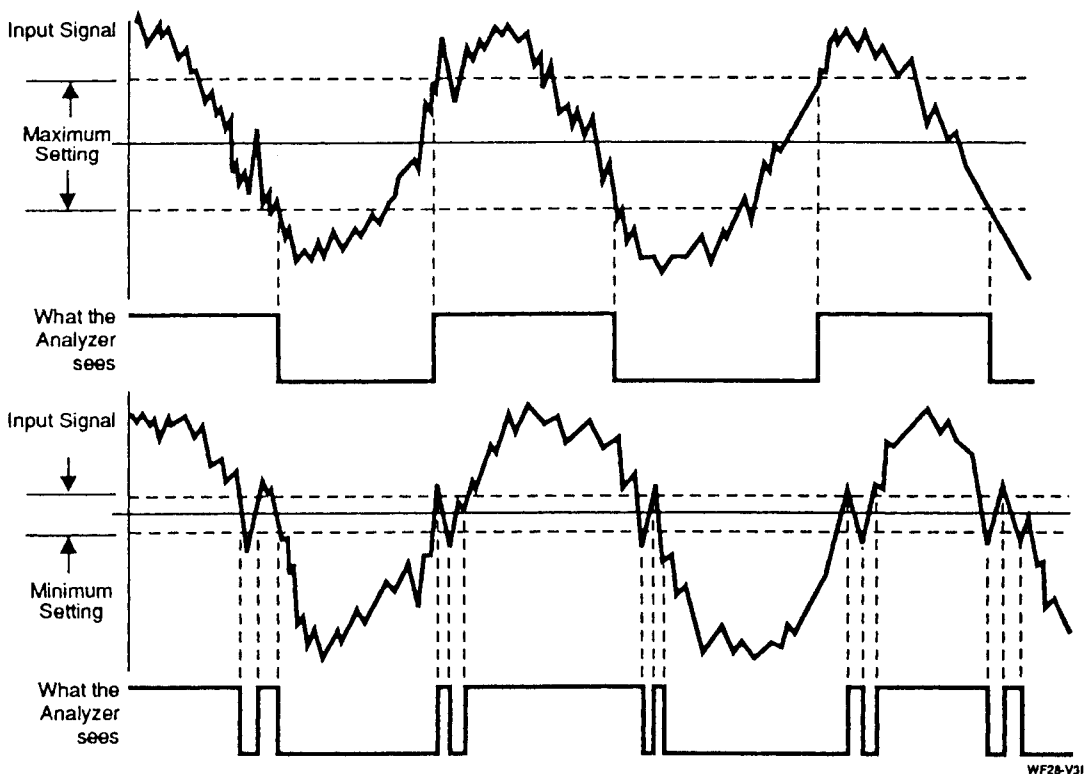

Figure 2-7. Minimum and Maximum Hysteresis Settings on a Noisy Signal

Input Menu

Comments **Hysteresis preset = Minimum**

Use the knob to change the Hysteresis setting. The voltage threshold setting is at the middle of the hysteresis band. The hysteresis feature is especially useful when measuring low slew-rate signals.

Related Features Voltage Threshold
Coupling
Impedance

***Related Programming
Commands*** [:SENSe]:EVENT:HYSTeresis

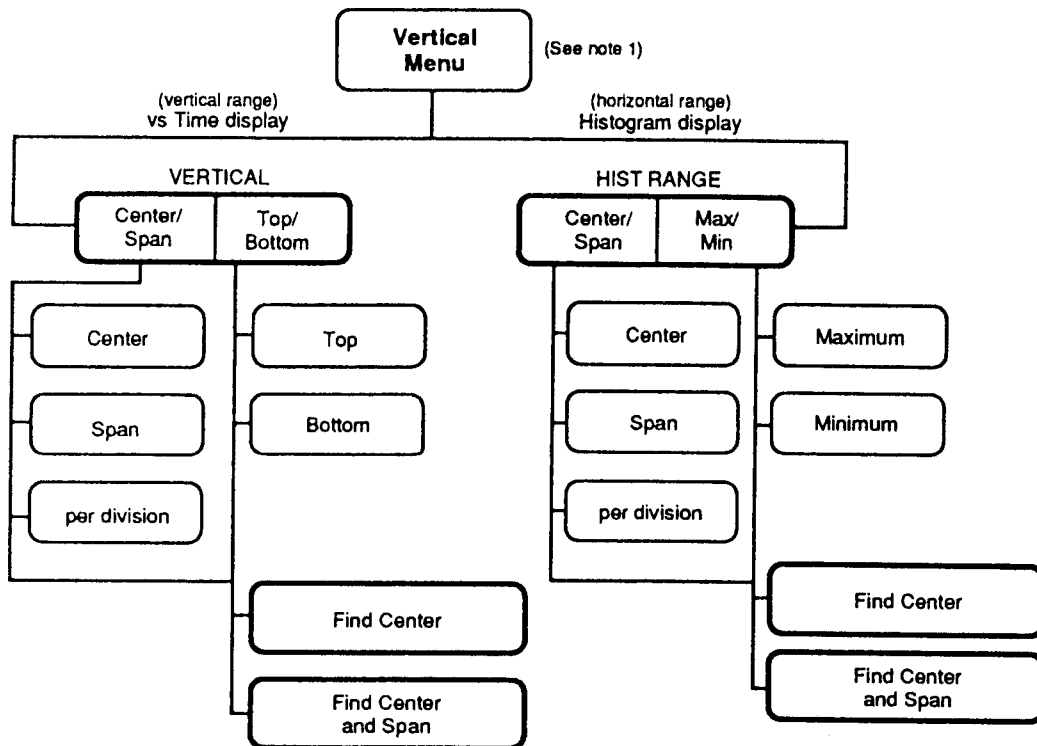

Notes

1. The Vertical Menu saves separate values for the following configurations:

- Frequency A
- Frequency B
- Frequency C (Option 030 C channel)
- Time Int A--B

For each configuration, the VERTICAL and HIST RANGE values are shared.

For example: VERTICAL Center = HIST RANGE Center
 VERTICAL Top = HIST RANGE Max

VERTICAL MENU

In This Chapter

Use the Vertical menu to set the frequency or time interval boundaries for the data to be displayed. The Autoscale feature automatically determines the Vertical menu values for your signal (see Autoscale description in chapter 1). This chapter describes how you can specify the frequency or time interval boundaries.

vs. Time or Histogram

The Analyzer has two modes for acquiring and displaying measurement data:

- vs. Time
- Histogram

The “vs. Time” mode displays frequency or time interval results as a function of time. The Histogram mode shows the distribution of the frequency or time interval results, organized by measurement value.

The “vs. Time” mode is the default mode selected by the Preset function. Use the Display or Histogram menu to select the “vs. Time” or Histogram mode.

Regardless of the acquisition mode selected, the settings on the Vertical menu apply to the measurement axis (Frequency or TI). For “vs. Time”, this axis is the y-axis, for histograms it is the x-axis.

NOTE

The Analyzer allows display range settings that exceed the specified frequency range of channels A, B, and C (Option 030).

Center/Span

The Center/Span parameters let you set measurement axis (Frequency or TI) boundaries by specifying the center value of the measurement range and then the range you wish to span. The center value is at the mid-point of the span. See the Center/Span illustration in *figure 3-1*.

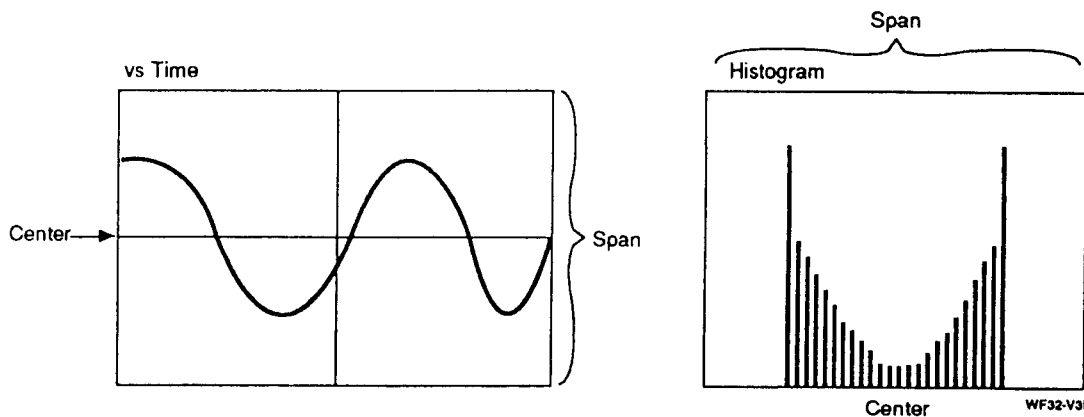

Figure 3-1. Center and Span for vs. Time and Histogram Modes

Comments

As the span is reduced, the measurement resolution increases.

In the process of setting the center value for frequency measurements, the span setting may be altered to maintain an 8:1 ratio limit for the maximum to minimum display range. Changing the span will never affect the center value. This 8:1 ratio is explained at the end of this chapter.

Related Features Top/Bottom
 Max/Min

***Related Programming
Commands*** [:SENSE]:FREQUENCY:RANGE:UPPER
 [:SENSE]:FREQUENCY:RANGE:LOWER
 [:SENSE]:TINTERVAL:RANGE:UPPER
 [:SENSE]:TINTERVAL:RANGE:LOWER

Per Division The softkey choice below the Span parameter lets you enter a “per division” value rather than a value for the entire span. This feature only has application to the “vs. Time” display. Any change to the “per division” value modifies the span. Since there are eight divisions along the vertical axis of the “vs. Time”, any change in the “per division” value will change the span eight times that amount. (Use the Grid option on the Display menu if you want to see the eight divisions more easily.)

Top/Bottom

The Top/Bottom parameters let you set measurement axis (Frequency or TI) boundaries by specifying the limits of the value range for the vs. Time display. See the Top/Bottom illustration in figure 3-2.

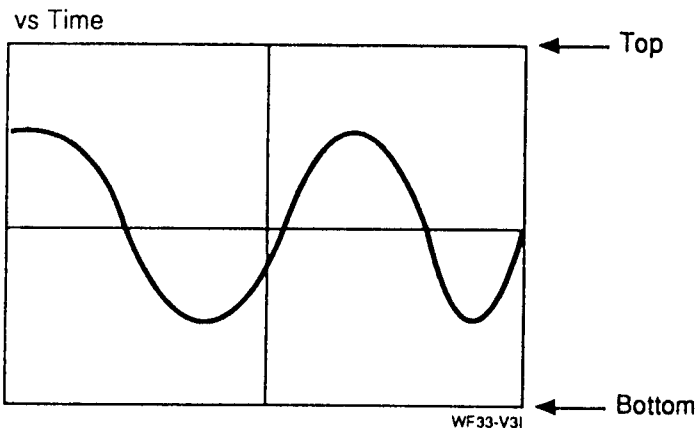

Figure 3-2. Top and Bottom for "vs. Time" Mode

Comments

When the Histogram mode is selected, the label over the softkeys is "HIST RANGE" and the corresponding parameter is Max/Min to reflect the different orientation of the value scale (top to bottom for "vs. Time", left to right for Histogram).

When using the Frequency function, interactions can occur between the top and bottom settings. The top value cannot be set greater than eight times the bottom value (see end of chapter).

Related Features

Center/Span
Max/Min

Related Programming Commands

```
[[:SENSe]:FREQuency:RANGe:UPPer  
[:SENSe]:FREQuency:RANGe:LOWer  
[:SENSe]:TINTerval:RANGe:UPPer  
[:SENSe]:TINTerval:RANGe:LOWer
```

Max/Min

The Max/Min parameters let you set the measurement axis (Frequency or TI) boundaries by specifying the limits of the Histogram display range. See the Max/Min illustration in figure 3-3.

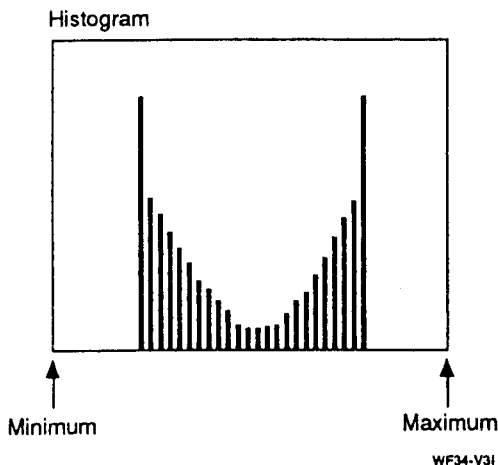

Figure 3-3. Maximum and Minimum for Histogram Mode

Comments

When the “vs. Time” mode is selected, the label over the softkeys is “VERTICAL” and the corresponding parameter is Top/Bottom to reflect the different orientation of the value scale (left to right for Histogram, top to bottom for “vs. Time”).

When using the Frequency function, interactions can occur between the max and min settings. The maximum value cannot be set greater than eight times the minimum value (see end of chapter).

Related Features

Center/Span
Top/Bottom

**Related Programming
Commands**

```
[[:SENSE]:FREQUENCY:RANGE:UPPER
[:SENSE]:FREQUENCY:RANGE:LOWER
[:SENSE]:TINTERVAL:RANGE:UPPER
[:SENSE]:TINTERVAL:RANGE:LOWER
```

Find Center

Find Center attempts to adjust the center value to correspond to the center value of your input. This feature is especially useful when you want to do that while maintaining your current measured span and timebase settings. For example, Find Center can be used to reposition a signal that has drifted off-screen.

Comments

The Find Center algorithm searches for the minimum and maximum values of the measurement data, even though some of the data may be outside the current display area. The Analyzer will then set the Center value to the middle of the measurement data, without regard to the amount of data inside or outside the display area.

Related Programming Commands

`[[:SENSE]:FREQUENCY:RANGE:CENTER:AUTO ONCE`

Find Center and Span

Find Center and Span attempts to adjust both the center and span values to provide a view of your input, given your currently selected timebase settings. This feature is especially useful when your signal has changed its overall modulation depth (so a span change is needed), or if it has drifted. However, if only centering is needed, the Find Center feature may be the preferred choice since it does not alter the span.

Comments

The Find Center and Span algorithm positions the frequency and time interval data so the maximum values are on the display. This may result in data being moved off the display to accommodate the maximum values. This behavior is similar to that of Autoscale.

Related Programming Commands

`[[:SENSE]:FREQUENCY:RANGE:AUTO ONCE`

Frequency Function Display Limits

For Auto sampling, there is an 8:1 ratio limit for the display of maximum to minimum frequency values. Another way of stating this is that the maximum frequency value can never be set greater than eight times the minimum frequency value. The Analyzer will modify previously set Vertical menu parameters to prevent this 8:1 ratio from being exceeded. Priority is always given to the parameter being changed, so any value can be entered for Top or Center, for example. Then the Bottom and Span parameters will be forced to new values, if necessary, so the 8:1 ratio is not exceeded. Read the Note below.

Example of 8:1 Ratio Limit

This example demonstrates how the 8:1 ratio limit operates.

You can try this example with the Analyzer by first setting it to the Frequency function and then following the steps below.

1. Set Top value to 8 MHz, set Bottom value to 1 MHz.
2. Now set the Bottom value to 500 kHz. The top value is forced to 4 MHz.

The 8:1 ratio is maintained.

3. Set the Top value to 10 MHz. The bottom value is forced to 1.25 MHz.

Again, the 8:1 ratio of maximum to minimum is maintained.

NOTE

If you need more than an 8:1 ratio of maximum to minimum vertical values, use Ext Edge, Time, or Fast sampling. Those modes provide a 64:1 ratio limit.

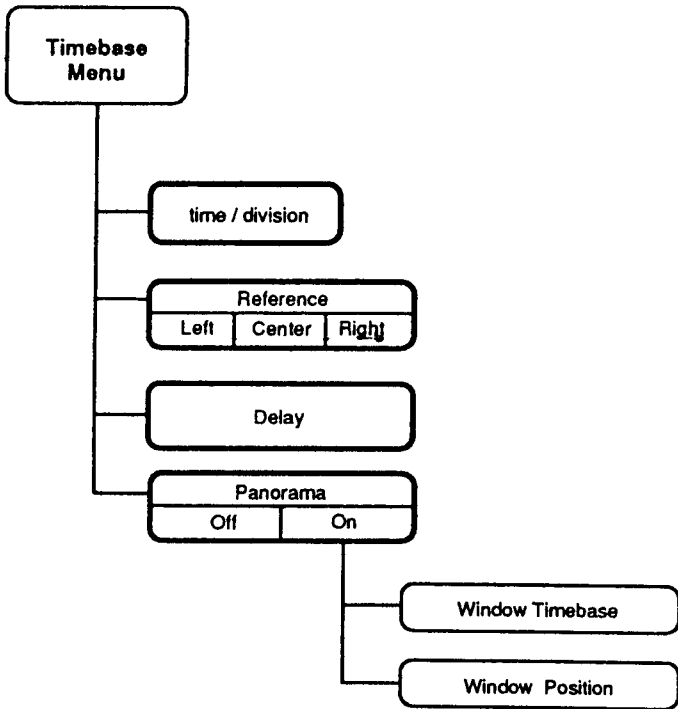

TIMEBASE MENU

In This Chapter

Use the Timebase menu to control the amount of time over which measurement data is acquired. This chapter describes the features to do the following:

- Control the amount of signal data that is acquired by the Analyzer.
- Change the reference position of the data on the display.
- Modify the value of the reference position on the display.
- Use the Panorama feature to acquire more than one display screen of measurement data at the selected time/div setting.

Time/Div

The time/division feature allows you to control the length of time over which measurement data will be acquired. Time of acquisition can be varied from 10 μ s (1 μ s/div) to 10 s (1 s/div).

NOTE

When using Panorama, the time over which you can acquire data is increased. For Analyzers without Option 001, Extended Measurement Memory, measurement data can be acquired for up to 20 times the horizontal timebase span. Analyzers with Option 001 can acquire up to 80 times the horizontal span.

NOTE

If you are making measurements where the time between measurements may exceed 364 divisions of the time/div value, you should read "Time Aliasing," at the end of this chapter.

Comments **Time/Div preset = 100 μ s/div**

When Sampling is set to Auto (on the Sampling menu), the time/division setting influences how often your input signal is being sampled. (For more information on sampling, refer to chapter 9, "Sampling.") The descriptions below describe the operation of Auto Sampling (the default setting) for frequency and time interval measurements.

Frequency Measurements: In general, the Analyzer tries to select a sample interval so it can collect approximately 200 measurement results over the timebase span. If you want to simulate "zooming-in" on your signal, reduce the time per division. The Analyzer will attempt to make approximately the same number of measurements using a shorter sample interval.

Time Interval Measurements: The Analyzer attempts to make 450 measurements over the timebase span. This equals the number of screen pixels across the "vs. Time" display. Fewer measurements will be displayed if the time between the occurrence of the time intervals exceeds the selected time between measurements. The selected time between measurements is the timebase span divided by 450.

Related Features Reference
 Delay
 Panorama

Related Programming [:SENSe]:SWEp:TIME:SPAN
Commands

Reference

The Reference feature lets you shift the position of the delay value to one of three reference points (see the Delay description below):

- Left edge of display.
- Center of display.
- Right edge of display.

The time/division, reference and delay settings work in association with the Trigger conditions (specified on the Trigger menu) to determine the portion of the signal that will be captured and displayed. The occurrence of the trigger is always assigned to 0.00 seconds on the display.

All timebase changes take place around the reference point (Left, Center, or Right) as follows:

- Left — Increasing the time/div value displays more data after the reference point.
- Center — Increasing the time/div value displays more data before and after the reference point.
- Right — Increasing the time/div value displays more data before the reference point.

Reference

Example Figure 4-1 shows the effect of changing the reference point. If the delay is set to 0.00 seconds and the reference is set to **Ctr**, the display shows pre-trigger data to the left of center and post-trigger data to the right (a). If the reference is changed to **Left**, only the data after the trigger event is displayed (b).

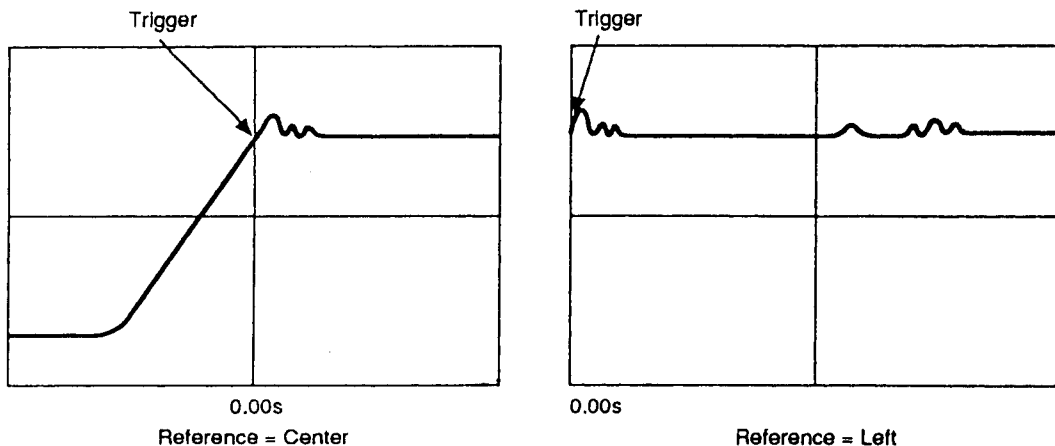

Figure 4-1. Illustration of the Reference Feature

Comments Reference preset = Ctr

Related Features Delay

Related Programming Commands [:SENSe]:SWEep:TIME:DELay:LINK
[:SENSe]:SWEep:PANorama:DELay:LINK

WF42-V31

Delay

The delay feature sets the horizontal axis value at the reference position on the display when Panorama is off. When Panorama is on, the delay feature sets the horizontal axis value at the reference position for the Panorama. The reference position can be at the left edge, center, or right edge of the display. Since the occurrence of the trigger is always assigned to 0.00 seconds on the display, think of it as being fixed in time. Modifying the delay value allows you to view the measurement results occurring before or after the trigger.

Example

With Reference = Ctr and Delay = $50\ \mu\text{s}$, the center of the display represents a point $50\ \mu\text{s}$ after the occurrence of the specified trigger condition. This shows more data after the trigger (post-trigger data).

With Reference = Ctr and Delay = $-50\ \mu\text{s}$, the center of the display represents a point $50\ \mu\text{s}$ before the occurrence of the specified trigger condition. This shows more pre-trigger data. See figure 4-2.

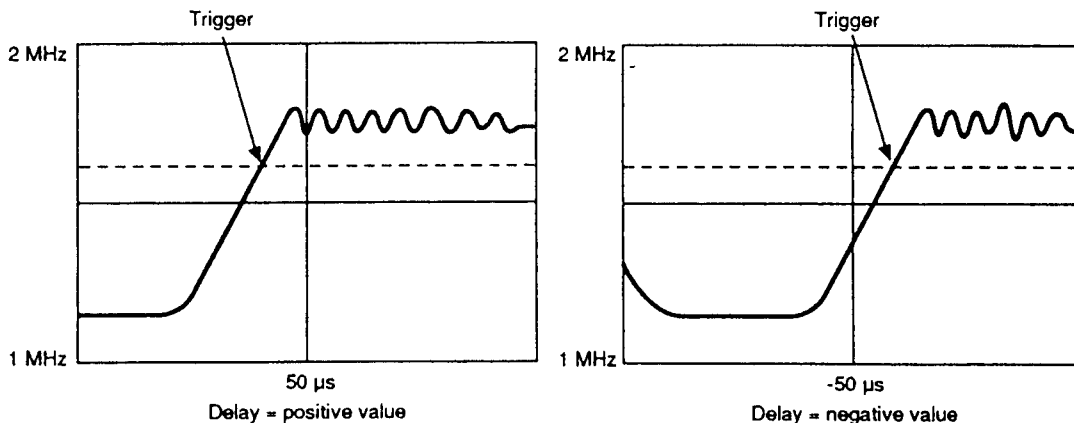

Figure 4-2. Illustration of the Delay Feature Using a Center Reference

Delay

Comments **Delay preset = 0.00 seconds**

The delay setting is always referenced to the trigger. The trigger is always referenced to 0.00 seconds on the “vs. Time” display. The trigger is the event, or condition, that initiates the display of measurement data.

With Panorama off (Panorama is explained later in this chapter), the “vs. Time” horizontal axis value at the reference point (left, center, or right) is the delay value.

With Panorama on, the Window Position value is at the reference point.

With Panorama on, the delay feature and the panorama timebase set the boundaries for the measurement acquisition.

Related Features Time/Div
Reference

***Related Programming
Commands*** [:SENSe]:SWEep:TIME:DELay
[:SENSe]:SWEep:PANorama:DELay

Panorama

The Panorama feature activates a second display area and timebase allowing you to collect multiple screens of data at any time/division setting.

NOTE

When the Panorama feature is turned on, the reduced display area at the top of the screen is called the panorama display, and the main display area below the panorama is referred to as the window display. The data that appears in the window display is data from the same acquisition as that shown in the panorama display.

The timebase control at the top of the screen, controls the overall time of acquisition (panorama timebase). The Window Timebase control, that appears when Panorama is on, specifies the time/div for how the measurement data is acquired. This influences how often the input signal is being sampled. (This sampling behavior is described in more detail under "Time/Div.")

The panorama timebase can be set 1 to 20 times the window timebase setting (for Analyzers without Option 001) or 1 to 80 times the window timebase setting for Analyzers with Option 001, Extended Measurement Memory.

There are indicators in the panorama display to highlight the portion of the panorama data currently being viewed in the window display. The Time markers, when activated, appear in both the panorama and window display areas.

NOTE

Turning on the Panorama will cause a new acquisition to take place. With the Analyzer stopped, a new acquisition occurs when any parameter on the Timebase menu is modified, with the exception of Window Position.

When Panorama is on, all analysis results are based on the panorama display data. Likewise, when the "Histogram From vs Time" display is selected with Panorama on, the histogram is based on the panorama display data.

Comments **Panorama preset = Off**

Operation of the Reference feature when Panorama is on:

1. When the reference position is set to **Left**, the left edge of the window display is fixed and all changes to the window timebase affect what is displayed to the right of this point.

2. When the reference position is set to **Right**, the right edge of the window display is fixed and all changes to the window timebase affect what is displayed to the left of this point.

3. With a **Center** reference position, all timebase changes take place around the fixed center point of the window display.

This behavior makes it easy to set a reference point for the window display within the panorama.

When Panorama is turned off, the main display assumes the values set for the window display. The window timebase setting becomes the time/div value, and the window position becomes the delay value.

Related Features

Reference
Delay

***Related Programming
Commands***

[[:SENSE]:SWEep:PANorama:STATe

Window Timebase

This feature sets the time/division in the window display and also sets the time/division that is used to acquire measurement data into the panorama display. (See Panorama description).

The window timebase can be set equal to the value of the panorama timebase. At that point, the data is the same in both displays. The window timebase value is limited to no less than 1/20th of the panorama timebase for an Analyzer without Option 001 and no less than 1/80th of the panorama timebase for an Analyzer with Option 001, Extended Measurement Memory.

Example

At any window timebase setting a maximum of either 20 screens of data or 80 screens of data can be acquired.

1. Maximum panorama timebase setting (no Option 001) = 20 seconds/div when the Window Timebase setting is 1 second/div.
2. Maximum panorama timebase setting (no Option 001) = 20 μ s/div when the Window Timebase setting is 1 μ s/div.
3. Maximum panorama timebase setting (Option 001) = 80 seconds/div when the Window Timebase setting is 1 second/div.
4. Maximum panorama timebase setting (Option 001) = 80 μ s/div when the Window Timebase setting is 1 μ s/div.

Comments

Window Timebase preset = 100 μ s/div

Related Features

Reference
Delay
Window Position

Related Programming Commands

`[:SENSe]:SWEep:TIME:SPAN`

Window Position

The Window Position feature lets you modify the value of the reference position on the display when Panorama is on. You can use this feature to select the portion of the panorama results to view in the window portion of the display. (See Panorama description).

NOTE

With the Analyzer stopped, Window Position can be changed to scroll through the acquired data. However, the Window Timebase cannot be used while the Analyzer is stopped to zoom in or out. A new acquisition will be required to collect and display data at the new setting.

When the Window Timebase equals the Panorama Timebase, there is only one possible setting for Window Position, the same as Delay.

Example

Follow these steps with or without data on the display:

1. Set Panorama feature to On.
2. Set the window timebase less than the panorama timebase.
3. Select the Window Position feature.
4. Rotate the knob and notice the indicators in the panorama display highlighting the portion of the panorama display that appears in the window display.

Window Position

Comments **Window Position preset = 0.00 seconds**

The window position cannot be set outside the boundaries of the panorama data. Any attempt to enter a window position value outside these boundaries (set by the panorama timebase and the delay value) will set the window position as far as possible in the specified direction, stopping at the panorama boundary.

Window position is the reference point when Panorama is on. If Panorama is off, the delay value is the reference point. Window position and delay are the same value when the panorama timebase is set the same as the window timebase.

Related Features Reference
 Delay
 Window Timebase

Related Programming Features [:SENSe]:SWEep:TIME:DELay

Time Aliasing

The Analyzer keeps track of input signal edges, and the time at which they occur, in order to properly compute measurements and relate them to one another. Should the device used by the Analyzer for counting this time reach its maximum count, it then restarts counting at zero. When this counter overflow occurs, the time relationship between measurements before and after the overflow is lost. The knowledge of when each sample occurred is lost. As a result, the measurements cannot be properly displayed in the “vs. Time” mode.

This condition can occur whenever the time between measurements exceeds 364 divisions of the time/div setting (there are ten divisions across the screen). The Analyzer cannot know when the overflow condition occurred, so you need to be aware of this possibility.

NOTE

Time Aliasing has no effect on measurements acquired using the Fast Histogram mode.

Situations Where Time Aliasing May Occur

There are primarily two measurement situations that would cause the time overflow condition in the Analyzer.

Setting the Timebase Incorrectly

In this situation, you select a timebase value inappropriate for your input frequency. For example, if you have a 100 Hz input and select a time/div value of 1 μ s, time overflow occurs because the signal events are occurring only once every 10 ms. Since 10 ms is greater than the entire measurement time (1 μ s/div x 10 div = 10 μ s), this is an incorrect setting of the timebase.

Time Aliasing

Having a Signal with Extended Off-Time

If you have a signal with no activity (no input edges) for longer than the overflow time, your measurement data will be affected. For example, a 100% AM modulated signal that has an off-time longer than 3.64 ms when your timebase value is 10 $\mu\text{s}/\text{div}$ could cause time aliasing to occur.

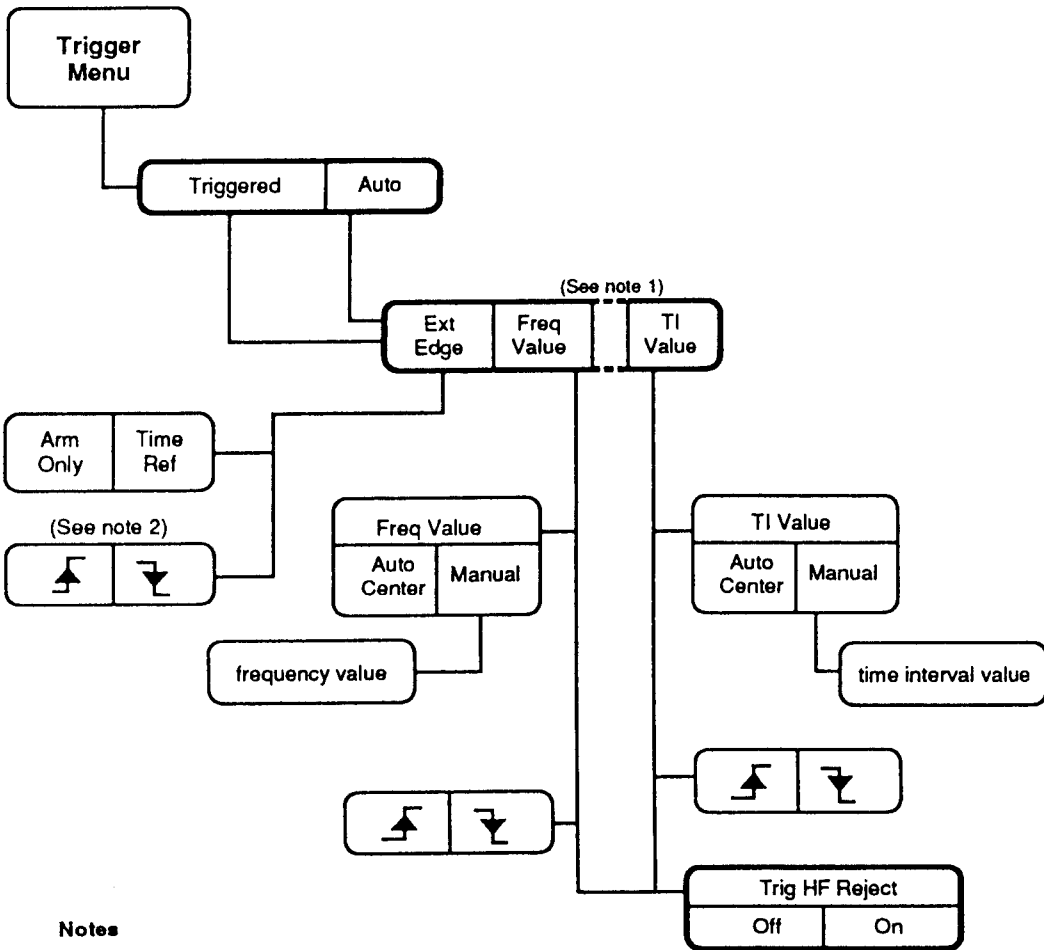

Notes

1. Either the Freq Value or the TI Value option will appear, depending on the selection of Frequency or Time Int A→B on the Function menu.
2. This slope setting is shared with the Fast Hist slope setting on the Histogram menu.

TRIGGER MENU

In This Chapter

Use the Trigger menu to specify the conditions that will control when measurement data is captured and displayed. This chapter describes the features to do the following:

- Select the triggering mode, Triggered or Auto.
- Select the trigger condition, Ext Edge or Value.
- For Ext Edge, choose Arm Only or Time Reference.
- For Value, trigger on measurement data that has high frequency components making it difficult for the Analyzer to stabilize the data on the display.

Trigger Mode

There are two triggering modes:

- **Triggered:** The Analyzer waits for a trigger to occur before displaying measurement results.
- **Auto:** Same as Triggered, except that if no trigger occurs within a pre-determined length of time, the Analyzer generates an internal auto trigger and will display any measurement results within the currently set measurement range.

Comments

Trigger Mode preset = Auto

Use Triggered and the Stop/Single key if you are making a single-shot measurement.

Related Features

Trigger Condition
Trigger HF Reject

Related Programming Commands

TRIGger:AUTO

Trigger Condition

Trigger Condition

The trigger condition specifies the event that will cause the Analyzer to capture and display measurement results. There are two conditions available:

- **Ext Edge:** An edge of the signal at the External Arm input.
- **Value:** A measured frequency or time interval value.

Comments

Trigger Condition preset = Value

Whenever Ext Edge is selected as the trigger condition, sampling by Ext Edge is not available on the Sampling menu.

Related Features

Trigger Mode
Ext Edge Slope
Value Mode
Value Slope
Trigger HF Reject

Related Programming Commands

TRIGger:SOURce EXTERNAL
TRIGger:SOURce LINK

Ext Edge Arming Mode

A signal at the External Arm input can be set to simply arm the measurement (Arm Only) or to provide a time record for the measurement (Time Reference). This time record is referenced to the instant at which the External Arm input signal occurred.

Comments

Ext Edge Arming Mode preset = Arm Only

Related Features

Trigger Condition
Ext Edge Slope

Related Programming Commands

TRIGger:FREQuency:EEMode

Ext Edge Slope This setting specifies whether the Analyzer triggers on a rising or falling edge of the signal at the Ext Arm input.

Comments Ext Edge Slope preset = rising slope

The voltage threshold for the external signal is set on the Input menu.

Related Features Trigger Condition

Related Programming Commands TRIGger:SLOPe

Value Mode There are two ways to specify the trigger value:

- **Auto Center:** The center of the measurement range is automatically specified as the trigger value. Any change to the center value on the Vertical menu is reflected on this menu.
- **Manual:** The trigger value can be specified manually.

Comments Value Mode preset = Auto Center

Use the knob or the Entry keypad to change the trigger value when the manual mode is selected.

Related Features Trigger Condition
Value Slope

Related Programming Commands TRIGger:FREQuency:LEVel
TRIGger:TINterval:LEVel

Trigger HF Reject

Value Slope This setting specifies whether the Analyzer triggers on a rising or falling slope of the measurement results.

Comments Value Slope preset = rising measurement slope

Related Features Trigger Condition
Value Mode

Related Programming Commands TRIGger:FREQuency:SLOPe
TRIGger:TINTerval:SLOPe

Trigger HF Reject Use this feature when you need to avoid triggering on high frequency modulation components (rapid measurement value changes) of your measurement data. When there are very fast value changes around the trigger point, the Analyzer may trigger inconsistently resulting in an unstable display of measurement results.

Comments Trigger HF Reject preset = Off

Related Features Trigger Mode
Trigger Condition

Related Programming Commands TRIGger:FREQuency:HFReject

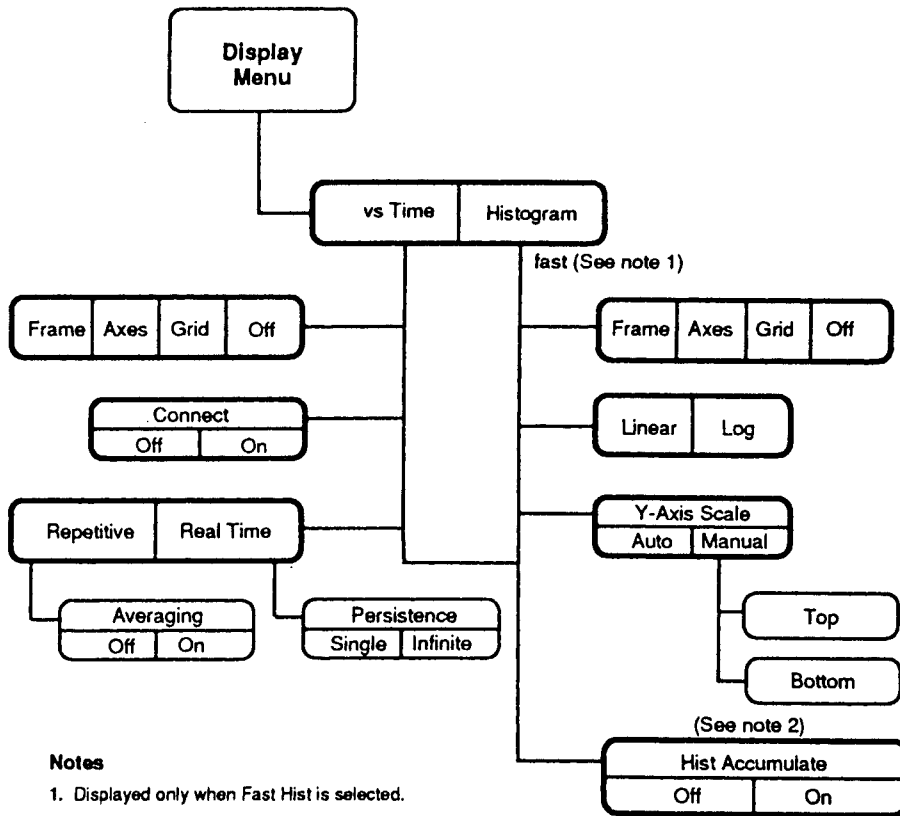

Notes

1. Displayed only when Fast Hist is selected.
2. When Hist Accumulate is on, data is collected in the histogram of the vs Time data even when the display is set to vs Time. This is not true for Fast Hist measurements. Data will accumulate for Fast Hist only when Fast Hist is selected. (See Histogram menu.)

In This Chapter

Use the Display menu to select the “vs. Time” or Histogram mode for the display of measurement data. This menu also provides access to controls that will affect how the data is displayed.

- The “vs. Time” mode acquires and displays measurements as a function of the time over which the measurements are collected.
- The Analyzer’s Histogram capability includes two types of histograms (select them on the Histogram menu):
 1. Histogram From vs. Time — This histogram mode displays measurements first acquired in the “vs. Time” mode. As a result, the characteristics of the “vs. Time” mode, such as sampling rate, trigger options, timebase setting, all determine the data shown in the Histogram From vs. Time. This histogram display is a narrow graph as wide as the “vs. Time” display is high. This is because whatever data appears along the *y-axis* of the vs. Time display is the *x-axis* data of the Histogram From vs. Time display.
 2. Fast Histogram — The Fast Histogram mode acquires data differently from the “vs. Time” mode. It can sample faster (see Sampling menu) and it is optimized for acquiring very large sample sizes (see Histogram menu).

vs. Time

For both histograms, the data shown is an approximate probability of occurrence distribution, with the y-axis scaled so it is easy to assess the % of the total measured data that lies within the defined analysis range. The analysis range can be the entire measurement acquisition, or only what is between limit markers (see the Marker menu). The Probability function is defined in chapter 1.

vs. Time

The “vs. Time” mode acquires and displays measurements (frequency or time interval) collected over the time span specified with the timebase control (see the Timebase menu).

The next series of paragraphs describe the features on the Display menu related to the “vs. Time” mode.

Comments

Display Mode preset = “vs. Time”

Related Programming Commands

[[:SENSe]:]FUNCTION
:CALCulate:HISTogram

Display Background for vs. Time Mode

This softkey choice is used to select the display background. Four options are available. They are described as follows:

- The **Frame** option displays an outside border that is marked with major and minor subdivisions. Actual values assigned to this graticule are determined by the y-axis values set on the Vertical menu and the x-axis values set on the Timebase menu.
- The **Axes** option displays a background with the measurement scale crossing at mid-screen dividing the display into four quadrants.
- The **Grid** background is a complete graticule with ten horizontal major divisions and eight vertical major divisions. Only the axis portion of the graticule has a minor division scale.
- The **Off** option turns off all display backgrounds.

Comments

Display Background preset = Axes

Related Programming Commands

:DISPlay:TRACe:GRATICule

Connect

Connect The Connect feature enables a “connect-the-dots” display of the measurement data. Lines are drawn on the display to connect each pair of consecutive data points.

Comments Connect preset = On

Related Programming Commands :DISPlay:TRACe:CONNect

Repetitive or Real Time

To understand the difference between the Repetitive and Real Time modes, you need to know a little about how data is presented on the display screen. The “vs. Time” display is 450 pixels columns wide. A pixel is the smallest discrete point that can be used to display a measurement result.

When set to Real Time, the pixels are turned off between each update. In the repetitive mode, a sequence of updates are merged and any pixels used to display data are not turned off between updates. If a more recent update puts a data point in a pixel column already occupied by data from a prior update, the result from the more recent update replaces the older data in that pixel column.

Comments Repetitive/Real Time preset = Real Time

Related Programming Commands [:SENSe]:SWEep:TIME:REPetitive

Real Time

The “vs. Time” data can be displayed one update at a time (Single Persistence) or many updates can be acquired with subsequent updates overlaying earlier ones (Infinite Persistence).

Comments **Real Time preset = Single Persistence**

*Related Programming
Commands* [:SENSe]:SWEep:TIME:REPetitive OFF

Single Persistence

The single persistence mode has the Analyzer display only the newly acquired data at the completion of each acquisition. Only the last update is displayed.

Comments Use this mode for single-shot measurements. This choice only appears when Real Time is selected.

*Related Programming
Commands* [:SENSe]:SWEep:TIME:REPetitive OFF
:DISPlay:TRACe:PERSiStence SINGLE

Infinite Persistence

In the infinite persistence mode, any pixels turned on to display data remain on over a sequence of updates. This is useful for seeing the total deviation of an input over time.

Comments This key only appears when Real Time is selected.

This differs from Repetitive in that with infinite persistence, it is possible to have multiple values per pixel column.

Persistence is a display-only feature. Analysis will operate only on the last update. Data read over HP-IB will only be the last update.

*Related Programming
Commands* [:SENSe]:SWEep:TIME:REPetitive OFF
:DISPlay:TRACe:PERSiStence INFinite

Repetitive

Repetitive

Updates on the "vs. Time" display are merged. Only one data point is allowed per pixel column (see "Repetitive or Real Time" above).

Comments **Repetitive preset = Averaging Off**

Related Programming Commands

`[[:SENSE]:SWEep:TIME:REPetitive ON`

Averaging Off/On

This feature is available when Repetitive is selected. With averaging on, the data in each pixel column is averaged with all data that occurs in that column. An average is maintained for each column.

Comments **Averaging preset = Off**

Histogram accumulation is unaffected by averaging. Only unaveraged data is collected in a histogram. Pressing the Clear Display key will restart the averaging.

Data read over HP-IB and the analysis functions use the repetitive result and not just the last update.

Related Programming Commands

`[[:SENSE]:SWEep:TIME:REPetitive ON`
`[[:SENSE]:SWEep:TIME:REPetitive AVERage`

Histogram

Only the Histogram From vs. Time mode can be selected on the Display menu. If you want the Fast Histogram mode, you must select it on the Histogram menu.

The x-axis is the range of measurement values. The y-axis is the probability of occurrence value (probability density).

Comments **Display Mode preset = vs. Time**

Related Programming Commands

`:CALCulate:HISTogram ON (Hist From vs. Time)`
`[[:SENSE]:FUNction`

Display Background for Histogram Mode

This softkey choice is used to select the display background. Four options are available. They are described as follows:

- The **Frame** option displays an outside border.
- The **Axes** option displays a background identical to Frame.
- The **Grid** background provides four vertical divisions for linear histograms. For log histograms, there are vertical divisions to represent decades. The number of divisions vary according to the top value for the histogram.
- The **Off** option turns off all display backgrounds.

Comments

Display Background preset = Axes

Related Programming Commands

:DISPlay:TRACe:GRATICule

Linear/Log This feature lets you select between two scaling modes for the y-axis of the histogram display, linear or log.

Comments **Linear/Log preset = Linear**

Related Programming Commands :DISPlay:TRACe:PROBability:SPACing

Linear This feature imposes a linear scale for the y-axis of the histogram.

An automatic linear scaling is used when the Y-Axis Scale feature is set to Auto. When set to Manual, you are able to specify the top and bottom boundaries. See the description under "Y-Axis Scale".

Comments Linear is useful when the central portion of a probability density is of interest.

Log This feature imposes a logarithmic scale for the y-axis of the histogram.

An automatic log scaling is used when the Y-Axis Scale feature is set to Auto. When set to Manual, you are able to specify the top and bottom boundaries. See the description under "Y-Axis Scale".

Comments Log is useful for looking at the small tails of a probability density without being distracted by the central portion.

Y-Axis Scale

The Y-Axis Scale feature can be set to Auto or Manual. When in auto, the y-axis maximum is internally selected, based on the maximum probability value of the histogram. The minimum is always zero. When Manual is selected, you can enter the top and bottom values for the histogram.

Comments

Y-Axis Scale preset = Auto

Scaling is by probability per pixel column; range is 0% to 100%. Auto scaling sets the maximum to the top of the display.

**Related Programming
Commands**

:DISPlay:TRACe:PROBability

Hist Accumulate

The Hist Accumulate feature makes it possible to accumulate data from multiple acquisitions into the selected histogram mode, Hist From vs. Time or Fast Histogram.

Comments

Hist Accumulate preset = Off

When the Analyzer is in the “vs. Time” mode and Hist Accumulate is set to On, data is will accumulate into the Histogram From vs. Time display, even though it is not currently selected. You can toggle between the “vs. Time” and Histogram From vs. Time modes.

**Related Programming
Commands**

:CALCulate:HISTogram:ACCumulate
[:SENSe]:HISTogram:ACCumulate

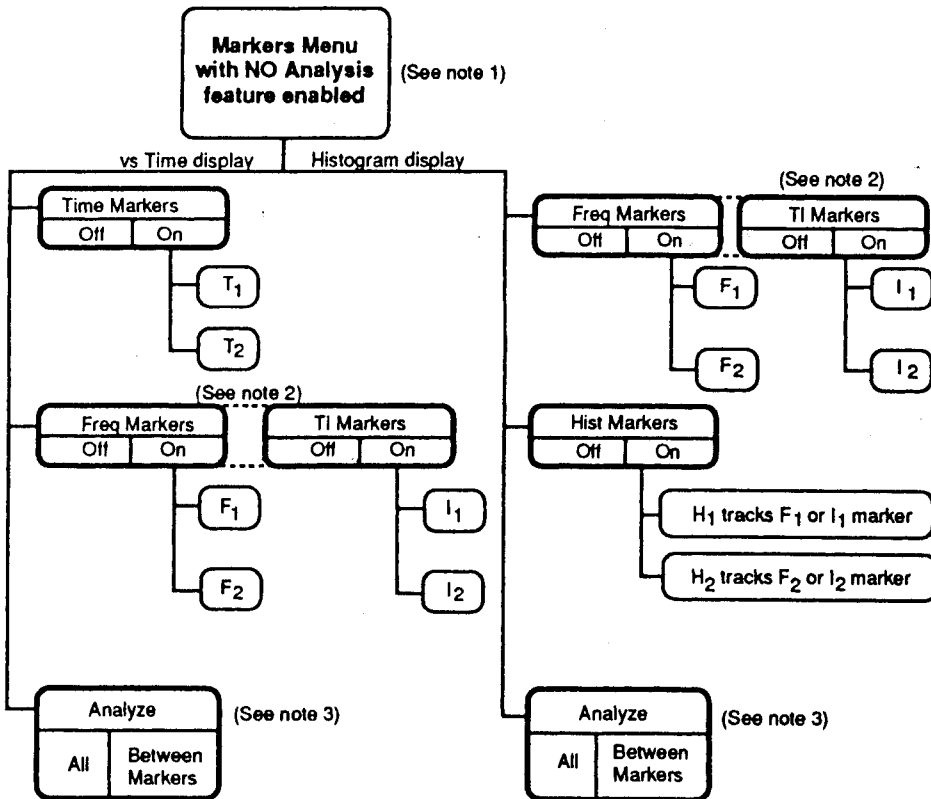

Notes

1. Analysis features are the shift-key features labeled in blue on the front panel.
2. Either Freq Markers or TI Markers option will appear depending on the selection of Frequency or Time Int A→B on the Function menu.
3. The Analyze option has no effect when there are no analysis features enabled.

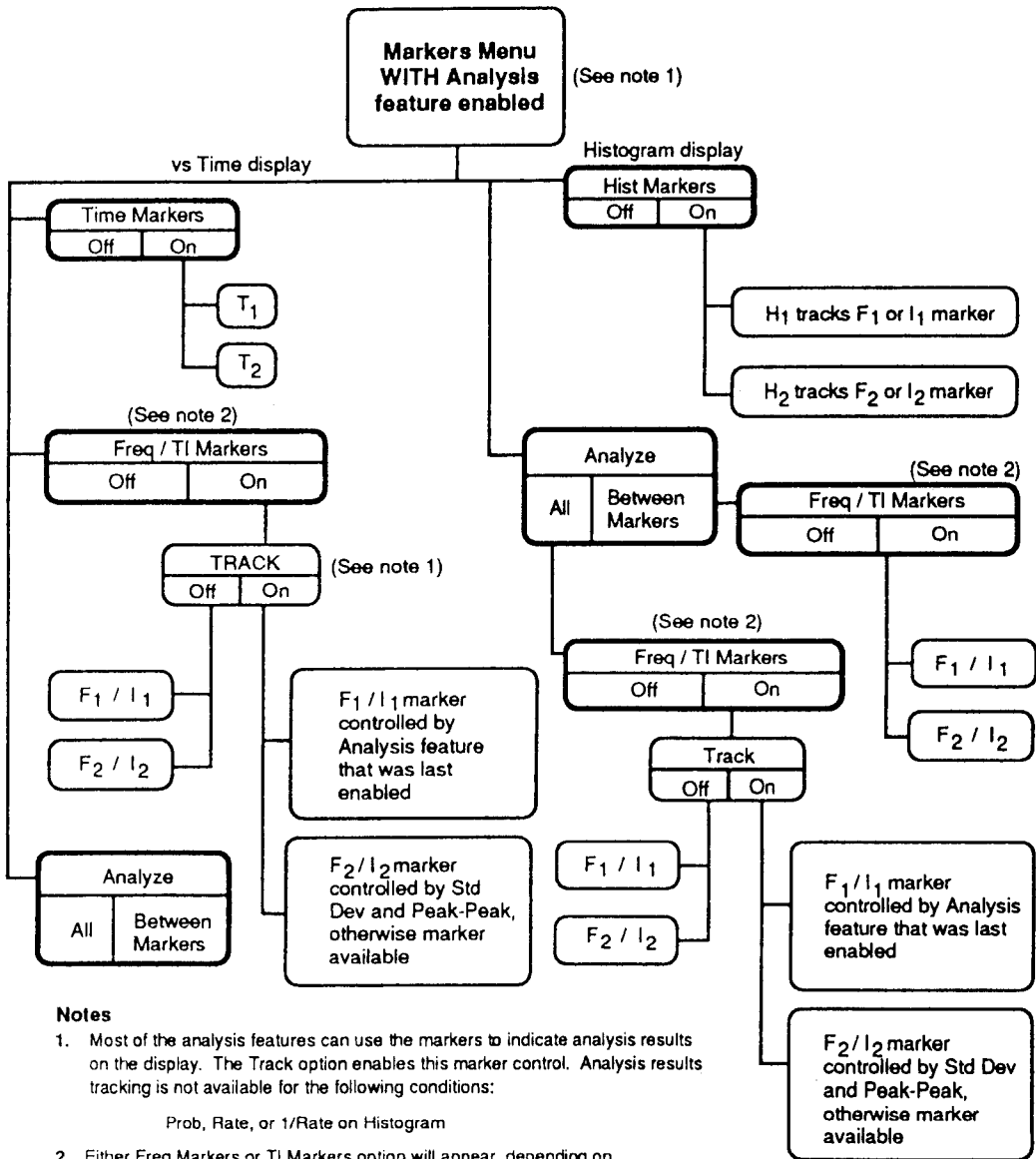

MARKERS MENU

In This Chapter

Use the Markers menu to select and control markers on both the “vs. Time” and histogram displays. This chapter describes how to use the markers to display delta values on measurement data, track analysis results on the display, and set the analysis range on the data.

Markers

There are two pairs of markers available on either the “vs. Time” or histogram displays.

Comments

Markers preset = Off

vs. Time Mode Markers

The markers for the “vs. Time” display can be used to identify frequency or time interval measurement data, the difference between measurement data points, the time at which data was measured referenced to the trigger, and the difference between two points in time.

The two pairs of markers move as follows on the “vs. Time” display:

- The Time markers move left and right on the display and show the time values, referenced to the trigger, at the position of the markers.
- The Freq or TI markers move up and down on the display and show the measurement range values at the position of the markers.

Markers

Comments The delta value is calculated as follows:

marker 2 - marker 1 = delta

Related Programming Commands

- :MARKer:TIME
- :MARKer:TIME:POSition
- :MARKer:FREQuency
- :MARKer:FREQuency:POSition
- :MARKer:TINTerval
- :MARKer:TINTerval:POSition

Histogram Mode Markers

The markers for the histogram display can be used to identify frequency or time interval measurement data, the difference between measurement data points, the difference between probability (actually relative frequency of occurrence) per pixel column.

- The Freq or TI markers move left and right on the display and show the measurement values at the position of the markers.
- The Hist markers move up and down on the display, tracking the measurement markers and show the probability values at the position of the corresponding Freq or TI markers.

Comments The delta value is calculated as follows:

marker 2 - marker 1 = delta

The histogram marker probability values at the position of the measurement markers will be displayed whenever the measurement markers are on.

Related Programming Commands

- :MARKer:FREQuency
- :MARKer:FREQuency:POSition
- :MARKer:TINTerval
- :MARKer:TINTerval:POSition
- :MARKer:PROBAbility
- :MARKer:PROBAbility:POSition

Marker Tracking

Frequency or TI markers can be set to track the analysis results and indicate the results on the displayed data. Marker tracking is supported for only one analysis function at a time. When more than one analysis function is enabled, it is the last function enabled (in the upper left of the analysis area below the marker readouts) that will control the markers. If that analysis function does not support marker tracking, no tracking will be available, even if other enabled analysis functions do support marker tracking.

The following configurations do not support marker tracking:

- Probability on “vs. Time” or histograms.
- Rate function on histograms.
- 1/Rate function on histograms.

The behavior of the markers with tracking is described in chapter 1 under “Analysis Functions.”

Whenever marker tracking is available, you have the choice of maintaining manual control of the markers. The choices are TRACK On or Off.

Related Programming Commands

:MARKer:FREQuency:POSition:AUTO
:MARKer:TINTerval:POSition:AUTO

Analyze

Use the Analyze feature to set the range for the analysis features described in chapter 1. Your choices for the range of analysis are as follows:

- **All** includes the entire acquisition in the analysis results.
- **Between Markers** causes only the measurement values between the x-axis markers to be included in the analysis results.

Comments

Analyze preset = All

Analyze **Between Markers** refers to the Time markers on the “vs. Time” and the measurement markers (Freq or TI) on the histogram displays.

If the measurement markers are off when **Between Markers** is selected, the markers will be turned on.

To enable an analysis feature, you first press the **Shift** key and then the desired feature as indicated in the following list:

- **Standard Deviation** (Shift, 0)
- **Probability** (Shift, .)
- **Mean** (Shift, 1)
- **1/Mean** (Shift, 2)
- **Maximum** (Shift, 4)
- **Rate** (Shift, 5)
- **1/Rate** (Shift, 6)
- **Minimum** (Shift, 7)
- **Peak-to-Peak** (Shift, 8)
- **Clear Analysis** (Shift, Clear)

There are several ways to disable analysis functions:

- Press the **Shift** key and then the **Clear** key. All enabled analysis functions will be disabled.
- Press the **Preset** key. All enabled analysis functions will be disabled.
- Enable a fifth analysis function. Four can be enabled at any one time. Enabling a fifth function will turn off the one first enabled.

All of the currently enabled analysis features automatically update each time new data is acquired.

There is no probability result for the “vs. Time” mode.
There is no Rate or 1/Rate result for histograms.

***Related Programming
Commands***

[:CALCulate:ANALysis:DELimit

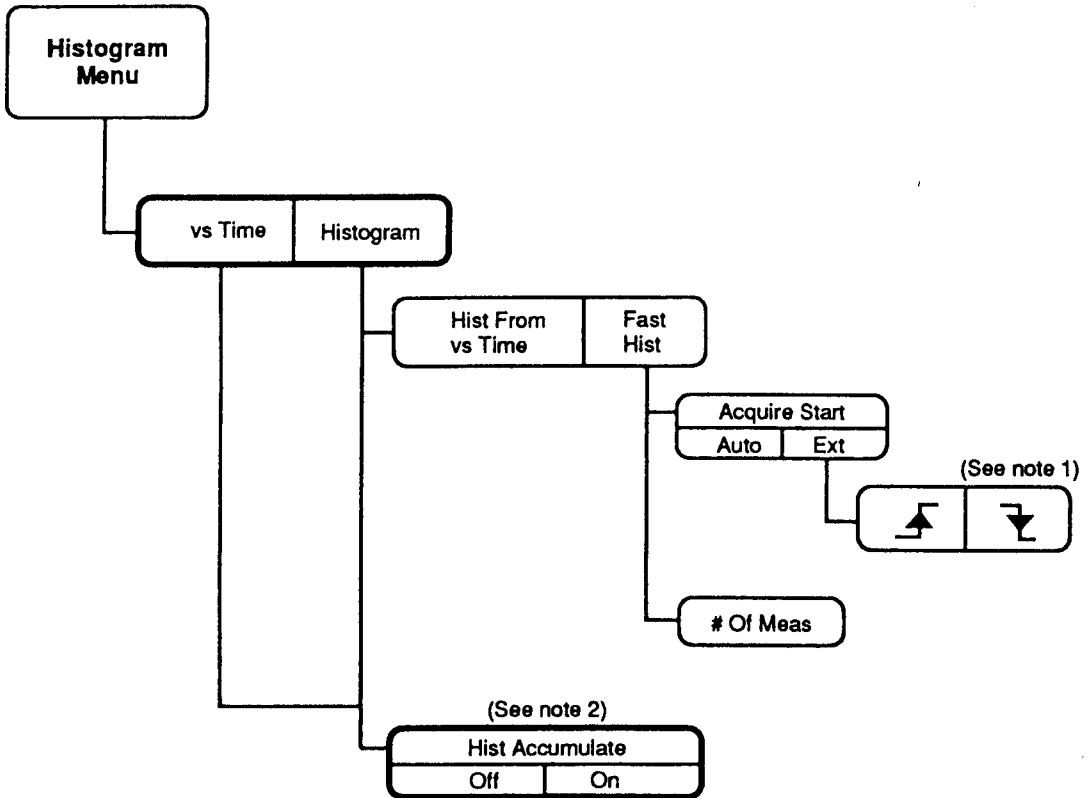

Notes

1. This slope setting is shared with the Ext Edge setting on the Trigger menu.
2. When Hist Accumulate is on, data is accumulated in the histogram of the vs Time even when the display is set to vs Time. This is not true for Fast Hist measurements. Data will accumulate for Fast Hist only when Fast Hist is selected.

HISTOGRAM MENU

In This Chapter

Use the Histogram menu to select the “vs. Time” or Histogram mode for the acquisition and display of measurement data. This menu also provides access to controls that will affect how the Fast Histogram acquires and displays data.

- The “vs. Time” mode acquires and displays measurements as a function of the time over which the measurements are collected.
- The Analyzer’s Histogram capability includes two types of histograms that are selected on this menu:
 1. Histogram From vs. Time — This histogram mode displays measurements first acquired in the “vs. Time” mode. As a result, the characteristics of the “vs. Time” mode, such as sampling rate, trigger options, timebase setting, all determine the data shown in the Histogram From vs. Time. This histogram display is a narrow graph as wide as the “vs. Time” display is high. This is because whatever data appears along the *y-axis* of the “vs. Time” display is the *x-axis* data of the Histogram From vs. Time display.
 2. Fast Histogram — The Fast Histogram mode acquires data differently from the “vs. Time” mode. It can sample faster (see chapter 9, “Sampling Menu,” for maximum sampling rates), and it is optimized for acquiring very large sample sizes.

vs. Time

For both histograms, the data shown is an approximate probability of occurrence distribution, with the y-axis scaled so it is easy to assess the % of the total measured data that lies within the defined analysis range. The analysis range can be the entire measurement acquisition or only what is between limit markers (see the Markers menu). The Probability function is defined in chapter 1.

vs. Time

The “vs. Time” mode acquires and displays measurements (frequency or time interval) collected over the time span specified with the timebase control (see Timebase menu).

Related Programming Commands

[**:SENSe**]:**FUNc**tion

Hist From vs. Time

The Histogram From vs. Time simply organizes into a histogram the data collected by the “vs. Time” mode.

Comments

An advantage of this type of histogram is that you have access to all the timebase and trigger controls when determining the setup for the data to be collected and then displayed in the Histogram From vs. Time. Additionally, when Panorama is set to on, it is the panorama data that is collected into this histogram. This allows you to take advantage of the enlarged sample sizes made possible with Panorama (see chapter 4, “Timebase menu”). Two of the disadvantages are the slower sample rate as compared to the Fast Histogram mode, and the more limited sample size available.

Related Programming Commands

:CALCulate:**HISTogram**

Fast Histogram

Fast Histogram, as the name implies, provides the fastest sampling rate the Analyzer can attain (see chapter 9, "Sampling Menu," for maximum sampling rates). This mode also provides the largest sampling size of any Analyzer measurement mode (see # Of Measurements in this chapter).

Comments

When in the Fast Histogram mode, you do not have access to the Timebase or Trigger menus. The only triggering condition available for Fast Histogram, besides Auto, is for starting the Fast Histogram acquisition on an external signal at the Ext Arm input.

The Fast Histogram mode is separate from the "vs. Time" mode and the same data cannot be shared between them. A new acquisition begins whenever the Analyzer is switched from the Fast Histogram mode to the "vs. Time" mode, or vice versa.

Related Programming Commands

[[:SENSe]:]FUNCTION

Data Display for Fast Histogram

There are up to 450 separate columns across the display into which data can be organized for Fast Histogram acquisitions. The number of columns used in any measurement situation depends on the Analyzer configuration (this includes measurement range settings, sampling mode, and number of measurements) and the data acquired.

Enlarged Display Columns

For every acquisition, the Analyzer attempts to divide the horizontal span of the Fast Histogram display into 450 discrete columns. This is not always possible. When the span of the measurement range is set so the Analyzer cannot resolve 450 divisions across the display, columns will be combined. This indicates that you are reaching the resolution limits of the Analyzer.

Acquire Start

The acquire start condition specifies the event that will cause the Analyzer to capture data in the Fast Histogram mode and display measurement results. There are two conditions available:

- **Auto:** The Analyzer will begin measuring as soon as it is ready.
- **Ext Edge:** An edge of the signal at the External Arm input will cause the Analyzer to start acquiring Fast Histogram data. You can specify a slope for the Ext Arm signal.

Comments

Acquire Start preset = Auto

Select Ext if you want to start the Fast Histogram with an external signal at the External Arm input. You can select a rising or falling edge. The alternative is to let the Analyzer automatically start a Fast Histogram whenever it is ready.

Whenever Ext Edge is selected as the condition that will begin a Fast Histogram acquisition, sampling by Ext Edge is not available on the Sampling menu.

Related Programming Commands

```
[[:SENSe]:]FUNctIon  
[:SENSe]:HISTogram:ARM:SOURce  
[:SENSe]:HISTogram:ARM:SLOPe  
:TRIGger:SLOPe
```

Of Measurements

This feature lets you set the number of measurements to collect in the Fast Histogram mode.

Comments

Of Meas preset = 1000

Range of values = 1 to 16,777,215 measurements.

The Analyzer will not complete an acquisition until the requested number of measurements have been collected within the set measurement range. The Analyzer reports the number of out of bounds measurements by displaying the number below the histogram display:

←345

112→

These out of bounds measurements are included in the probability calculation, but not in any of the other analysis function results (see “Analysis Functions,” in chapter 1).

Related Programming Commands

`[:SENSe]:HISTogram:TRIGger:COUNT`

Hist Accumulate

The Hist Accumulate feature makes it possible to accumulate data from multiple acquisitions into the histogram, Hist From vs. Time or Fast Histogram.

Comments

Hist Accumulate preset = Off

When the Analyzer is in the “vs. Time” mode and Hist Accumulate is set to On, data will accumulate into the Histogram From vs. Time, even though it is not currently selected. You can toggle between the “vs. Time” and Histogram From vs. Time modes.

Related Programming Commands

`:CALCulate:HISTogram:ACCumulate`
`[:SENSe]:HISTogram:ACCumulate`

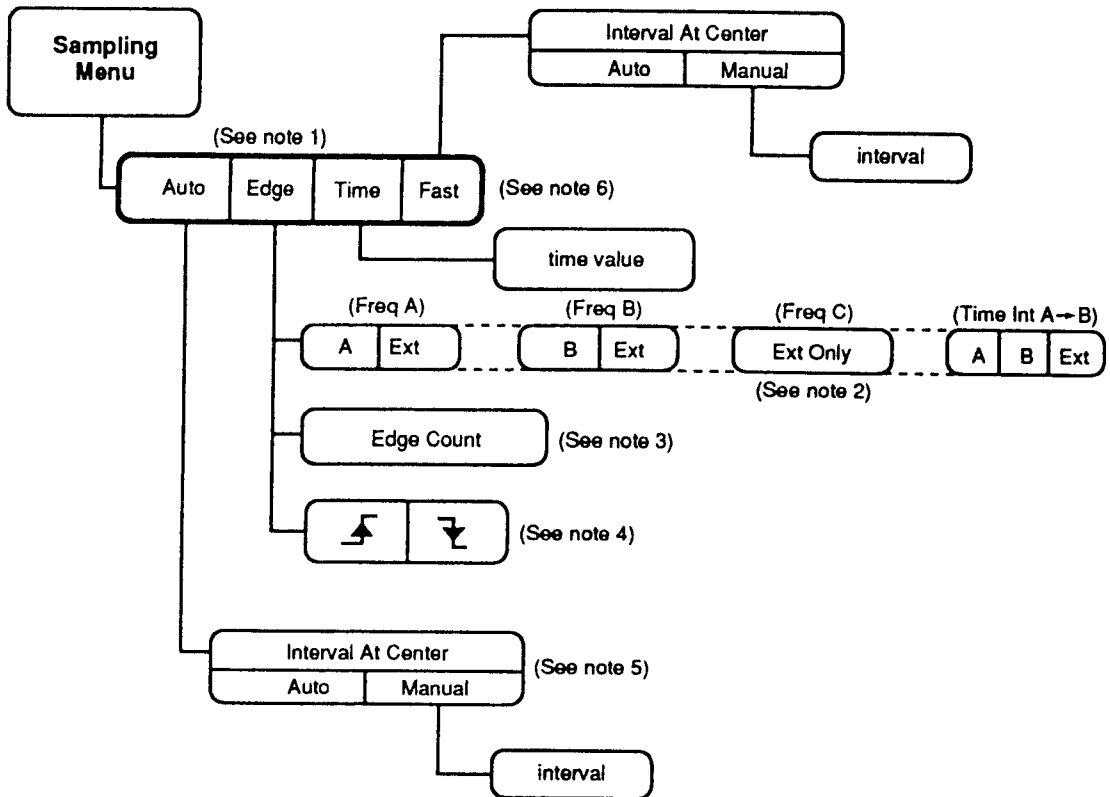

Notes

1. The Sampling type can be set separately for Frequency and Time Int A→B functions.
2. Measurement function and channel settings (on the Function menu) determine the edge sampling choices.
3. The edge count is fixed at 1 for Ext sampling. When Frequency is selected, the edge count value for channel A must be an even number. Channel B edge count can be an even or odd number. With Time Int A→B selected, the edge count for either channel can be even or odd.
4. Three slope settings can be used: one for Ext, one for channel A, and one for channel B. Slope settings for channel A and B can be specified only for Time Int A→B measurements.
5. This option appears only when Auto sampling is selected for a Frequency measurement.
6. Fast sampling appears only when Frequency is selected.

SAMPLING MENU

In This Chapter

This chapter explains how you can use the Sampling menu to take control of the sampling process. Unless your application requires some specialized sampling feature, it is recommended that you leave the sampling mode set to Auto. The other sampling modes can add measurement capability, but they can also increase the complexity of making measurements.

What is Sampling?

Sampling is the process of counting and timing the voltage threshold crossings of an input signal.

A Frequency Sample

A frequency sample consists of two quantities: a cumulative count of voltage threshold crossings (edges) of the input signal and the precise time period over which the edges were counted. From such samples collected in a sequence, frequency results are derived. The results are acquired for the “vs. Time” (and Histogram From vs Time) mode or for the Fast Histogram mode.

A Time Interval Sample

A time interval sample consists of the precise time at which an edge (voltage threshold crossing) occurs. The time difference between a start sample and a stop sample is a time interval.

Maximum Sample Rate for Analyzer Measurement Modes

Maximum Sample Rate for Analyzer Measurement Modes

Use *table 9-1* to determine the maximum sampling rates for the Analyzer's different measurement modes and sampling configurations.

*Table 9-1. Maximum Sampling Rates**

Function	Mode	Auto	Edge A/B	Edge Ext Arm	Time
Frequency	Fast Hist	1.5 MHz	1.5 MHz	(see table on next page)	(see table on next page)
	vs. Time	1.0 MHz	1.0 MHz	(see table on next page)	(see table on next page)
+TI	Fast Hist	2.5 MHz	2.5 MHz	2.5 MHz	2.5 MHz
	vs. Time	1.25 MHz	1.25 MHz	1.25 MHz	1.25 MHz
±TI	Fast Hist	2 MHz	2 MHz	2 MHz	2 MHz
	vs. Time	1.25 MHz	1.25 MHz	1.25 MHz	1.25 MHz

* Fast Sampling: A fast sampling mode (7.5 MHz rate) is provided for frequency measurements. This sampling mode requires repetitive signals.

Maximum Measurement Rate for Frequency with Ext Arm or Time Sampling

Use *table 9-2* to determine the approximate maximum sampling rates for frequency with sample by Time or sample by Edge on Ext Arm. One column is the ratio of center value to span value (set on Vertical menu). The second column specifies the approximate minimum time between samples. The reciprocal of that interval is the approximate maximum sampling rate, listed in the third column.

Maximum Sample Rate for Analyzer Measurement Modes

Table 9-2. Ext Arm and Time Sampling Rates

Ratio of Center/Span	Approximate Minimum Sampling Interval	Approximate Maximum Sampling Rate
1:1	3.64 μ s	275 kHz
10:1	4.70 μ s	213 kHz
100:1	5.77 μ s	173 kHz
1000:1	6.83 μ s	146 kHz
10000:1	7.89 μ s	127 kHz
100000:1	8.96 μ s	112 kHz
1000000:1	10.0 μ s	100 kHz

An advisory message, "Sampling interval may be multiple of selected value", will appear on the display when intervals are set below these values. See the example below for more on this topic.

Example

When the sample interval is set below the approximate minimum value for a particular ratio of center value to span, a multiple of the selected interval may be used for your measurements as described below:

If the center frequency is set to 10 MHz with a span of 1 kHz, the ratio is 10000:1. The minimum sampling interval from *table 9-2* is 7.89 μ s. If 3 μ s is entered as the Time sampling interval (or 3 μ s Ext Arm intervals if using Edge on Ext Arm), the longest sampling interval will be the first multiple that exceeds 7.89 μ s, which is 9 μ s. Because of the variables involved in how the Analyzer makes measurements, it is possible that many of the measurement intervals will actually be 3 μ s or 6 μ s with this setup. To set the Analyzer to use the same interval value for its measurements in this example, the Time sampling value should be set to 9 μ s.

Formula for calculating minimum sample interval:

$$\text{Sample time} = (3640 \text{ ns}) + (320 \text{ ns}) \left(\log_2 \frac{\text{center}}{\text{span}} \right)$$

Auto Sampling

When the sampling selection is Auto, the Analyzer automatically determines how to sample your input signal. The criteria used to make these sampling decisions vary depending on the measurement function.

Frequency vs. Time and Auto Sampling

For frequency measurements, there is a continual conflict between the need to sample faster in order to see higher modulation rates, and the need to sample slower in order to achieve better measurement resolution. To always sample as fast as possible would often not provide the needed measurement resolution.

In the auto sampling mode, the Analyzer selects an appropriate sampling interval based upon your selection of the time over which to collect measurement data (set with the time/division control on the Timebase menu). It is assumed that as you select shorter measurement times, you are interested in seeing more signal dynamics, which require shorter sampling intervals. As the time/div setting decreases, the sampling interval also decreases. The Analyzer attempts to select a sampling interval that will produce approximately 200 results across the "vs. Time" display (this assumes that Panorama is off).

Comments

With the Fast Histogram mode, the Analyzer selects an appropriate sampling interval when the Autoscale routine is executed, or you can control the sampling interval using the manual mode of Interval At Center (described later in this chapter).

Why Use Anything But Auto?

The fundamental reason you would want to choose something other than auto sampling is that you require a sampling interval other than that chosen by Auto. By overriding the auto choice, you de-couple the relationship between measurement time and the sampling interval. When you do this, you must be careful to maintain a reasonable relationship between the measurement time (controlled on the Timebase menu) and the sampling interval (controlled on the Sampling menu). For example, it doesn't make sense to select a sampling interval of 100 ms when the total measurement time is only 10 ms (1 ms/div on the Timebase menu). The Analyzer assumes you are paying attention to this measurement time/sampling interval relationship.

Frequency and Timebase Relationship

The Analyzer measures on edges of the input signal. If the input edges do not occur often, a screen with only a few data points across it may result. Whenever you have selected a sampling condition that would result in samples spaced at intervals longer than the sweep time, the message, "Timebase setting too fast for sampling value," will appear.

As a guideline for the fastest timebase value based on the input frequency, here is a table that assumes you want at least 50 points across the screen. A slower timebase may always be used.

Table 9-3. Frequency and Time / div

Frequency	Fastest Timebase for 50 points
10 Hz	500 ms/div
100 Hz	50 ms/div
1 kHz	5 ms/div
10 kHz	500 μ s/div
100 kHz	50 μ s/div

**Situations Where
You Would Want to
Override Auto
Sampling**

There are measurement applications where auto sampling would not be the best choice because it does link the time/div setting and the sampling interval.

Stability Measurement

For stability measurements, the samples may need to be collected at a prescribed time spacing. If left in auto sampling, the sampling interval would vary when the time/div value is changed.

***Measurement
Resolution versus
Signal Dynamics***

Any situation where you want to adjust for an optimum balance between the need for measurement resolution and signal dynamics would call for breaking the link between measurement time and sampling interval. For example, suppose you were analyzing a modulated signal and realized that you couldn't get enough resolution to adequately see the modulation. If you wanted to keep the measurement time constant, you couldn't use the time/div control to pick up additional resolution. By taking control of the sampling interval, you could lengthen the sampling interval (to improve the measurement resolution) without altering the measurement time. This is useful when auto sampling is significantly over-sampling your modulation, or you want to use the sampling interval control to examine your modulation at various modulation bandwidths.

Frequency Sampling Modes

When making frequency measurements, you have the following choices to specify how often samples of the input are collected:

- Auto
- Edge of the measured signal or External Arm signal
- Time
- Fast

Comments **Frequency Sampling preset = Auto**

Related Programming Commands [:SENSe]:FREQuency:ARM:SOURce

Interval At Center

When the sampling mode is set to Auto (top softkey on Sampling menu), there is a softkey below labeled "Interval At Ctr". This feature can be set to either the auto or manual state. It has several purposes:

- When set to Auto, it provides an indication of the sampling interval currently being used by the Analyzer.
- When in Manual, it allows you to set the sampling interval.

Comments **Interval At Center preset = Auto, 5.0 μ s interval**

Interval At Center range = 800 ns to 500 ms

Related Programming Commands [:SENSe]:FREQuency:ARM:SOURce
[:SENSe]:FREQuency:ARM:CFINterval

Frequency Sampling Modes

What is Interval At Center?

With Auto-sampled frequency measurements, the Analyzer uses a measurement method that provides better resolution than traditional frequency measuring techniques. Conventional techniques evaluate the input signal only once at the beginning of the sampling interval and once at the end of the interval.

A characteristic of the implementation of this method in the Analyzer is that each measured interval requires a constant number of edges from the input (an edge is a detected voltage threshold crossing of the input signal). Since the number of edges is constant per sample, the time per sample is dependent on the actual frequency of the input. The higher the frequency, the less time it takes to accumulate the same number of edges.

For any specified frequency, the time it takes to produce a constant number of edges is known. Thus, the control is called "Interval At Center," referring to the fact that when the input frequency is at the center frequency (specified on the Vertical menu), the sampling interval will be the value you have selected. If the input frequency goes up, the interval will be shorter, if the frequency goes down, the interval will be longer.

Auto Sampling (with Auto Interval at Center)

When using the "vs. Time" mode, the sampling interval choice is determined from the time/div setting on the Timebase menu. The selected interval can be seen on the sampling menu, beneath the softkey labeled "Interval At Ctr" on the Sampling menu.

Auto Sampling (with Manual Interval at Center)

You should use Interval at Center/Manual when you want to continue using the measurement method provided by auto sampling, but want to hold the Interval at Center value to a relatively fixed value. Having switched to Manual, you can be sure that this sampling interval approximation will not change when other parameters affecting the measurement time are changed. If you select Preset or Autoscale, the Interval at Center mode is reset to Auto.

Comments Notice that on transition from Auto to Manual, the numeric field will highlight, indicating that the value can now be set. The initial value is the same as was used when the state was Auto. This provides a starting point from which to customize your choice for the sampling interval.

Edge Sampling

When you change the sampling mode from Auto to Edge (using the top softkey), you can now specify the sampling interval in terms of edges (an edge is a threshold crossing of the signal in the direction indicated by the slope control, if available). If you select edge sampling from the input signal (for example, Frequency on channel B, sampled by channel B), the measurement technique will be the same as is used in auto sampling (higher resolution than traditional frequency measurement methods). If the sampling interval is set externally (signal on Ext Arm input), the measurement algorithm is traditional, accumulating the total edge counts between consecutive external edges and dividing by the time between the first and last edges to obtain the frequency.

Comments **Edge preset = Channel A = 2 edges**
Channel B = 1 edge
Channel C = Ext Only (Option 030)
Ext Arm = 1 edge

Channel A edge range = 2 to 256, in steps of 2

Channel B edge range = 1 to 256

Channel C edge range = 1 edge only on External Arm

External Arm edge range = 1 only

NOTE

Sampling on an external edge (Ext Arm) is not available as a sampling choice whenever Ext Edge is selected as the trigger condition on the Trigger menu, or Ext Edge is selected as the condition that will begin a Fast Histogram acquisition on the Histogram menu.

For either edge sampling selection mode, the sampling interval is not predictable because it depends on either the input frequency (if edge sampled by the measured input) or the external frequency (if sampled externally). You need to consider what the typical sampling interval will be, given your expectations for the input you are using to set the sample interval and the sampling interval requirements of the Analyzer. See the example that follows.

***Edge Sampling on
Input Signal***

When you sample on the signal being measured, the actual edge count used by the Analyzer may be a multiple of the edge count you entered (this behavior will be indicated in the softkey area of the Sampling menu). It will occur if the sampling interval equivalent of your original edge count is less than the minimum sampling interval (maximum sampling rate) of the Analyzer.

For example, you are trying to measure a 10 MHz input signal, and you select an edge count of 2. In order to sample as specified, the Analyzer would have to take a sample every 200 ns (a sample every two periods of the 10 MHz input signal). This is not possible because the Analyzer's maximum sampling rate (in the "vs. Time" mode) is 1.0 MHz (1 μ s interval). So, in this case, the Analyzer will use a multiple of the original edge count so that the Analyzer's requirements are satisfied. The edge count used by the Analyzer will be reported in the softkey area of the display.

***Related Programming
Commands***

[[:SENSE]:FREQUENCY:ARM:SOURce
[:SENSE]:FREQUENCY:ARM:ECOunt
[:SENSE]:FREQUENCY:ARM:SLOPe

Time Sampling

By selecting this sampling mode, you invoke a measurement mode similar to that found on many frequency counters. The sampling interval is now paced at the interval you specify, with each interval remaining essentially constant, regardless of the input frequency. It should be noted that this method of measuring frequency provides less resolution for any given measurement interval than the auto sampling measurement method or edge sampling on the measurement channel.

Comments

Time preset = 50.0 μ s

Time range = 3 μ s to 1 second

The only reason to use time sampling would be because you need to pace the measurements at a certain time interval. You may be able to use auto sampling to accomplish this, by selecting Manual Interval at Center. This mode is different from time sampling in that the sampling interval will vary with the input frequency, but if this is an acceptable characteristic (which would be the case if you are measuring a constant frequency), you can take advantage of the better resolution that auto sampling provides.

***Related Programming
Commands***

[[:SENSE]:FREQUENCY:ARM:SOURce
[:SENSE]:FREQUENCY:ARM:TIMer

Fast Sampling

Fast sampling is described at the end of this chapter.

Frequency Sample Mode Examples

Frequency Sample Mode Examples

On the next several pages are diagrams illustrating the edge and time sampling modes available for frequency measurements. For the purpose of these diagrams, it is assumed that the input signal being measured is below the maximum sample rate of the Analyzer.

Frequency with Source Sampling

Source Sampling (Edge Count = 2)

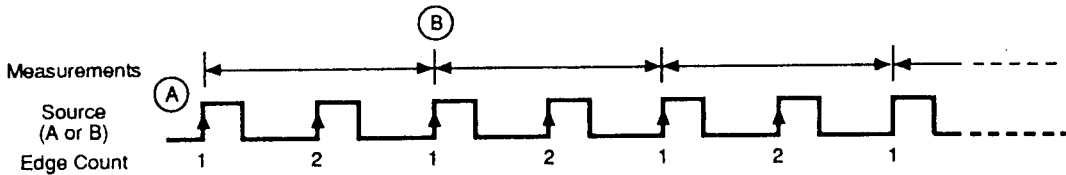

- (A) The first edge detected by the Analyzer (can be rising or falling edge) begins the first measurement and the edge count.
- (B) The edge following the two counted edges ends the first measurement and begins the next.

WF91-V31

Figure 9-1. Frequency with Source Edge Sampling

Frequency with Ext Arm Sampling

External Arm Sampling (Edge Count = 1 Only)

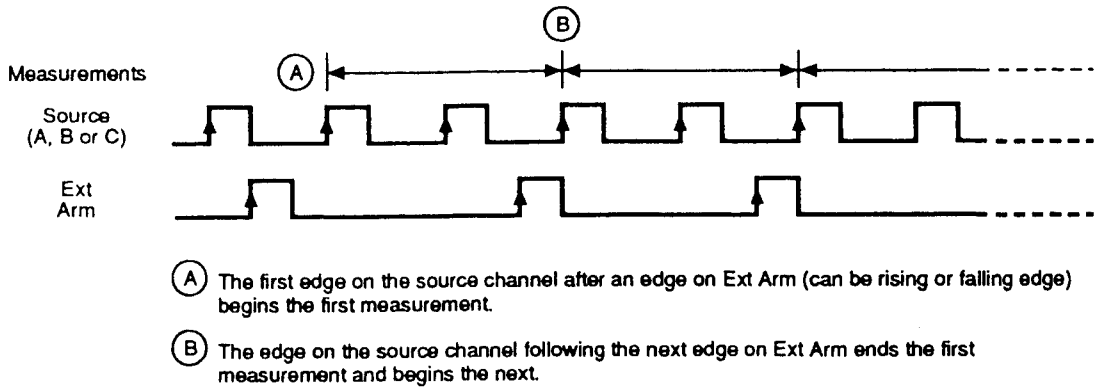

WF92-V3

Figure 9-2. Frequency with Ext Arm Sampling

Frequency with Time Sampling

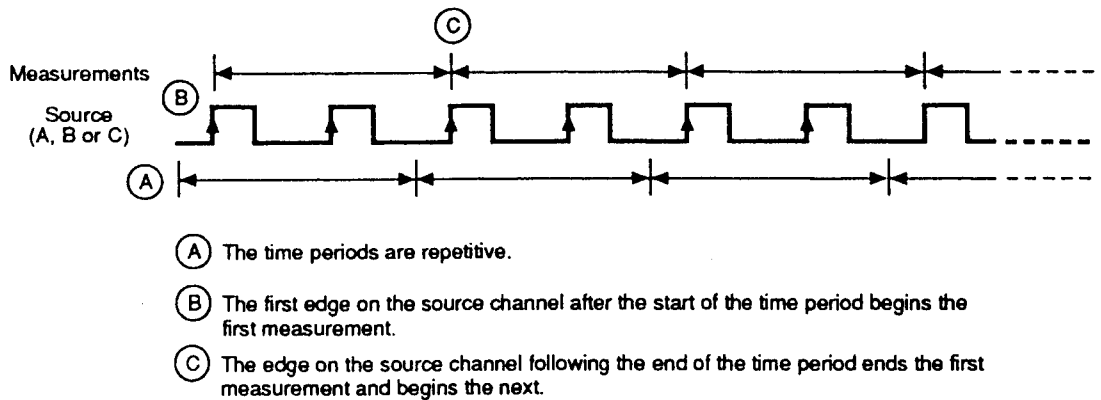

WF93-V3

Figure 9-3. Frequency with Time Sampling

Time Interval and Auto Sampling

Unlike frequency measurements, where the resolution of the result is dependent on the sampling interval, time interval resolution is constant, regardless of the sampling interval. This simplifies the sampling choices compared with frequency. There is no Interval at Center control. If you want to set an interval between measurements, use time sampling.

Time Interval Sampling Modes

When making time interval measurements, you have the following choices to specify how often time interval measurements are collected:

- Auto
- Edge on the input signal or External Arm
- Time

Comments **Time Interval Sampling preset = Auto**

Related Programming Commands `[[:SENSe]:TINTerval:ARM:SOURce`

Auto Sampling

In auto-sampled TI, the selected sampling interval can be seen on the sampling menu, at the softkey labeled "Auto Time." This value (like the time sampling value) is an indication of how often the Analyzer will attempt to measure a time interval. If several time intervals occur during the sampling interval, the first one is collected and the rest are discarded. If you want to measure as many intervals as possible, adjust the time/div control as appropriate (shorter time/div values will have the Analyzer measure more intervals).

Comments **Auto Time preset = 2.222 μ s**

Two other methods for measuring time intervals as often as possible are:

1. Use Time sampling and set a short time value.

2. Use Edge sampling with an edge count of 1.

The Fast Histogram will sample at the Analyzer's fastest rate when set to the auto sampling mode.

Related Programming Commands

[[:SENSe]:TINTerval:ARM:SOURce AUTO

Edge Sampling

With edge sampling, you can specify the interval between measurements in term of edges (an edge is a threshold crossing of the signal in the direction indicated by the slope control).

Comments

**Edge preset = Channel A = 1 edge
Channel B = 1 edge
Ext Arm = 1 edge**

Channel A edge range = 1 to 256

Channel B edge range = 1 to 256

External Arm edge range = 1 only

Related Programming Commands

[[:SENSe]:TINTerval:ARM:SOURce
[:SENSe]:TINTerval:ARM:ECOUNT
[:SENSe]:TINTerval:ARM:SLOPE

Time Sampling

With time sampling, you can specify the interval between measurements.

Comments

Time preset = 10 μ s

Time Sampling range = 400 ns to 1 second

Related Programming Commands

[[:SENSe]:TINTerval:ARM:SOURce
[:SENSe]:TINTerval:ARM:TIMER

Time Interval Sample Mode Examples

Time Interval Sample Mode Examples

On the next several pages are diagrams illustrating the edge and time sampling modes available for time interval measurements. For the purpose of these diagrams, it is assumed that the input signals being shown are below the maximum sample rate of the Analyzer.

+TI with Source A Sampling

If in the situation shown in *figure 9-4*, the edges on B did not occur as frequently as the edges on A (for example, there might be four edges on A for every edge on B), measurements will not be occurring every two edges on A.

Source Sampling on Channel A (Edge Count = 2)

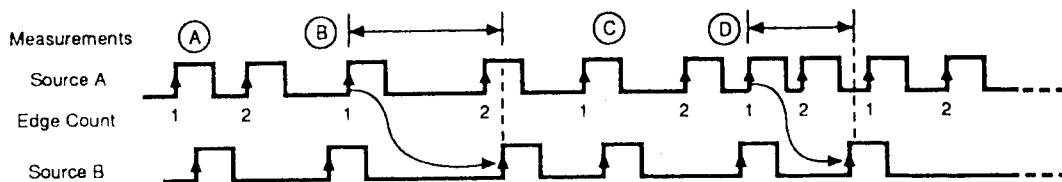

- (A) The Analyzer must count two edges on channel A before the first measurement can begin.
- (B) Once two edges (Count = 2) have been counted on A, the Analyzer will begin a measurement on the next specified edge on channel A (rising edge in this example).
- (C) The Analyzer is instructed to prepare to measure after every 2 edges on channel A. No measurement occurs here because the Analyzer was busy making the previous measurement when the instruction was issued. Two more edges must be counted before the next measurement can begin.
- (D) +TI measurements are always made from the first edge on A, after the Analyzer is ready, to the next edge on B, that follows the edge on A by at least 20 ns.

WF94-V31

Figure 9-4. +TI with Source A Edge Sampling

***+TI with Source B
Sampling***

Source Sampling on Channel B (Edge Count = 2)

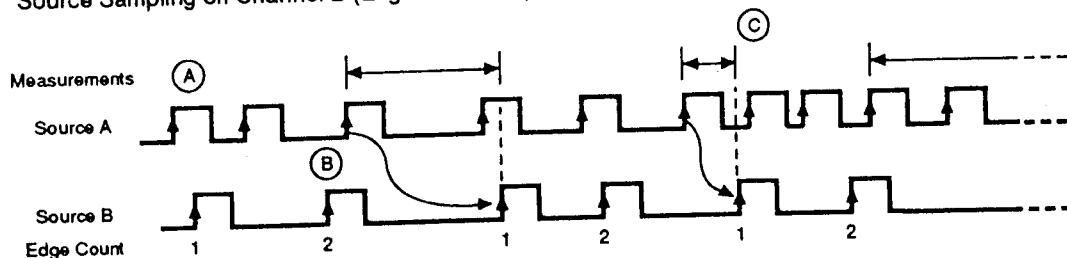

- (A) The Analyzer must count two edges on channel B before the first measurement can begin.
- (B) Once two edges (Count = 2) have been counted on B, the Analyzer will begin a measurement on the next specified edge on channel A (rising edge in this example).
- (C) +TI measurements are always made from the first edge on A, after the Analyzer is ready, to the next edge on B, that follows the edge on A by at least 20 ns.

WF05-V31

Figure 9-5. +TI with Source B Edge Sampling

Time Interval Sample Mode Examples

+TI with Ext Arm Sampling

External Arm Sampling (Edge Count = 1 Only)

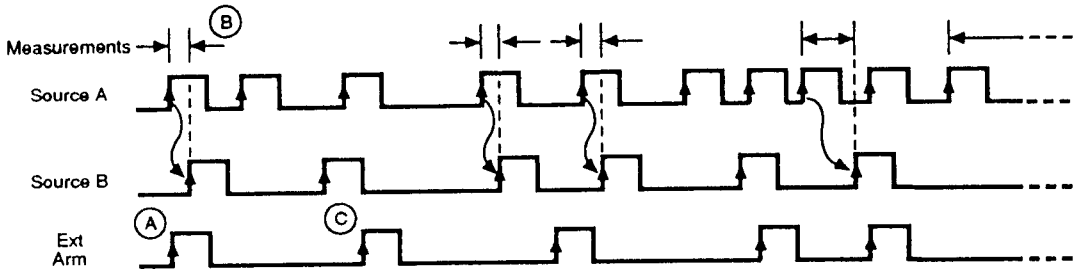

- (A) Once an edge occurs on Ext Arm (rising edge in this example), the Analyzer will begin a measurement on the next edge on channel A.
- (B) +TI measurements are always made from the first edge on A, after the Analyzer is ready, to the next edge on B, that follows the edge on A by at least 20 ns.
- (C) The external edge determines when the Analyzer is ready to begin measurements.

WF94-V31

Figure 9-6. +TI with Ext Arm Sampling

+TI with Time Sampling

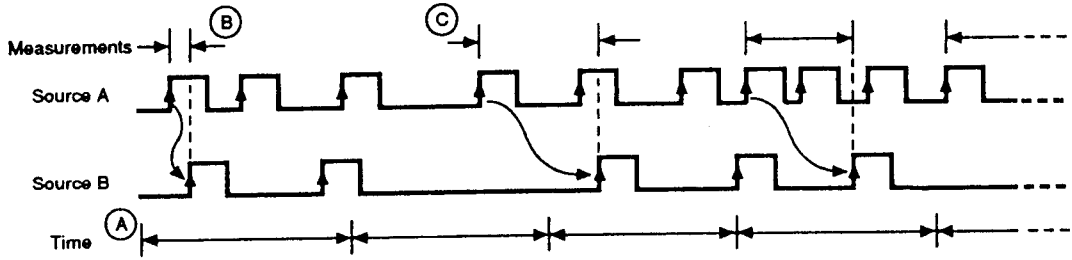

- (A) The time periods are repetitive.
- (B) The first measurement can occur after the start of the time period.
- (C) When a measurement overlaps two time periods, the next measurement cannot begin until after a new time period starts.

WF97-V34

Figure 9-7. +TI with Time Sampling

Time Interval Sample Mode Examples

$\pm TI$ with Source A Sampling

Source Sampling on Channel A (Edge Count = 2)

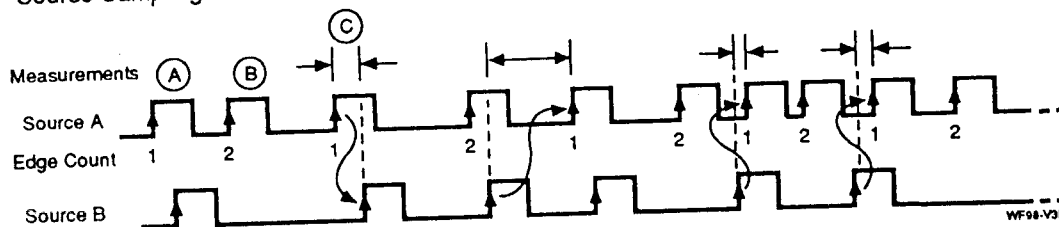

- (A) The Analyzer must count two edges on channel A before the first measurement can begin.
- (B) Once two edges (Count = 2) have been counted on A, the Analyzer will begin a measurement on the next specified edge on channel A or channel B.
- (C) An edge occurs first on channel A, after the Analyzer is ready. The $\pm TI$ measurement is from the edge on A to the next edge on B. The result is positive. When B leads A, the result is negative.

Figure 9-8. $\pm TI$ with Source A Edge Sampling

**$\pm TI$ with Source B
Sampling**

Source Sampling on Channel B (Edge Count = 2)

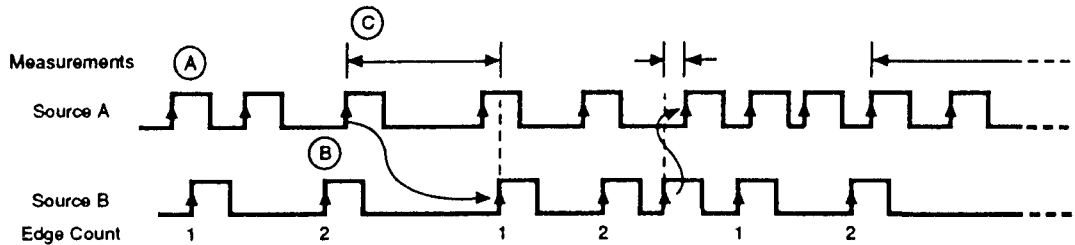

- (A) The Analyzer must count two edges on channel B before the first measurement can begin
- (B) Once two edges (Count = 2) have been counted on B, the Analyzer will begin a measurement on the next specified edge on channel A or channel B.
- (C) An edge occurs first on channel A, after the Analyzer is ready. The $\pm TI$ measurement is from the edge on A to the next edge on B. The result is positive. When B leads A, the result is negative.

WF96-V31

Figure 9-9. $\pm TI$ with Source B Edge Sampling

Time Interval Sample Mode Examples

$\pm TI$ with Ext Arm Sampling

External Arm Sampling (Edge Count = 1 Only)

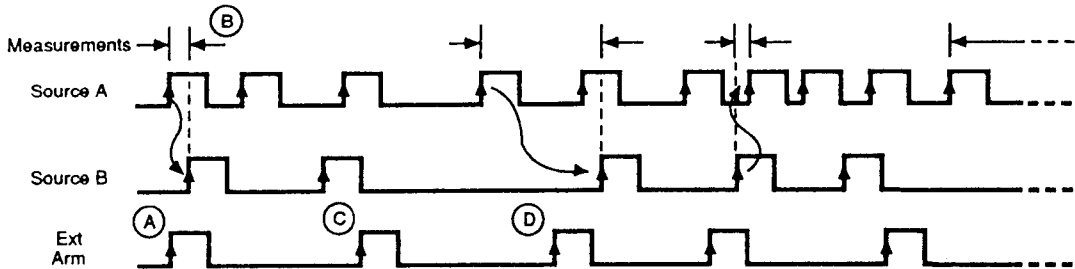

- (A) Once an edge occurs on Ext Arm (rising edge in this example), the Analyzer will begin a measurement on the next edge on channel A or B.
- (B) An edge occurs first on channel A, after the Analyzer is ready. The $\pm TI$ measurement is from the edge on A to the next edge on B. The result is positive. When B leads A, the result is negative.
- (C) The external edge determines when the Analyzer is ready to begin measurements.
- (D) An edge on Ext Arm occurring during a measurement is ignored.

WF9_1-V31

Figure 9-10. $\pm TI$ with Ext Arm Sampling

$\pm TI$ with Time Sampling

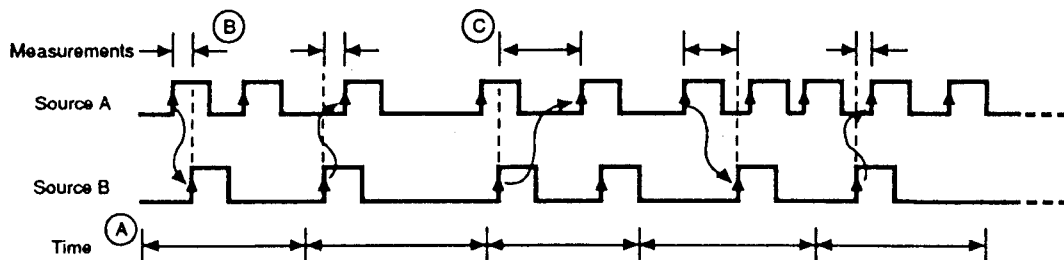

- (A) The time periods are repetitive.
- (B) The first measurement can occur after the start of the time period.
- (C) One measurement can occur within each time period. When an edge on B leads A, the result is negative.

WF9_2-V31

Figure 9-11. $\pm TI$ with Time Sampling

Fast Sampling

Fast sampling provides a sampling rate up to 8.0 MHz for frequency measurements on repetitive signals. This increased sampling rate is achieved by making a series of short acquisitions until enough data is collected to fill the vs. Time display or the histogram. Each acquisition uses a longer time delay in order to measure consecutive segments of the data. The data is then combined before it is displayed. When displayed, it appears as if the data was acquired in a single sweep, similar to how the other sampling modes operate. This sampling mode can take longer to acquire and display measurement data because of this segmented acquisition scheme. See the Note below.

NOTE

When set to Fast sampling, the HP 53310A makes consecutive acquisitions of 16 measurement samples until enough data is collected to fill the display. This can be up to 225 measurement samples across the vs. Time display representing 14 separate acquisitions. Each of these acquisitions requires a trigger. For example, if 225 measurements were needed and the trigger condition was an edge at the External Arm input, 14 trigger edges, along with the signal being measured, would be needed before enough measurement data would be acquired and displayed.

For more on Interval At Center, see the description earlier in this chapter.

**Operating
Characteristics**

Fast sampling increases the effective sampling rate up to 8 MHz. But when using Fast sampling there are certain behaviors you need to understand.

- Because of how Fast sampling operates, it is recommended that you do not use Fast sampling to search for an unknown signal. Use Auto sampling to first find and display the signal, then switch to Fast sampling.
- Use the triggered mode (see Trigger menu) when using Fast sampling. This provides a reference for the multiple acquisitions collected as part of the Fast sampling mode.
- When Connect Data is on (see Display menu), you can see which samples are grouped together in each sampling group separated by a gap.
- The Fast sampling mode is not able to show pre-trigger data.

Comments

Interval At Center preset = Auto, 5.0 μ s interval

Interval At Center range = 125 ns to 1 ms

When set to Auto, the Interval At Center displays the sampling interval currently being used by the Analyzer.

When set to Manual, you can set the sampling interval.

**Related Programming
Commands**

[[:SENSe]:FREQuency:ARM:SOURce
[:SENSe]:FREQuency:ARM:FCFInterval

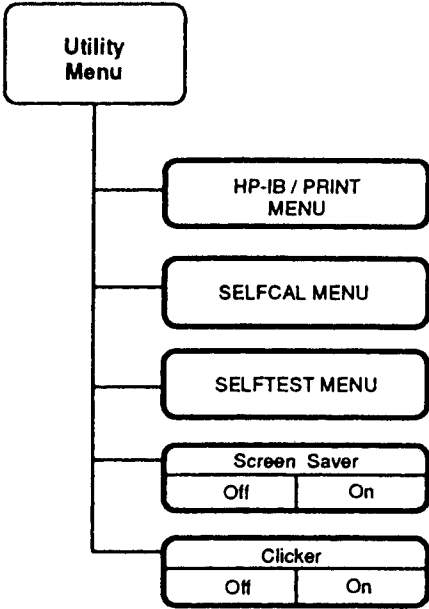

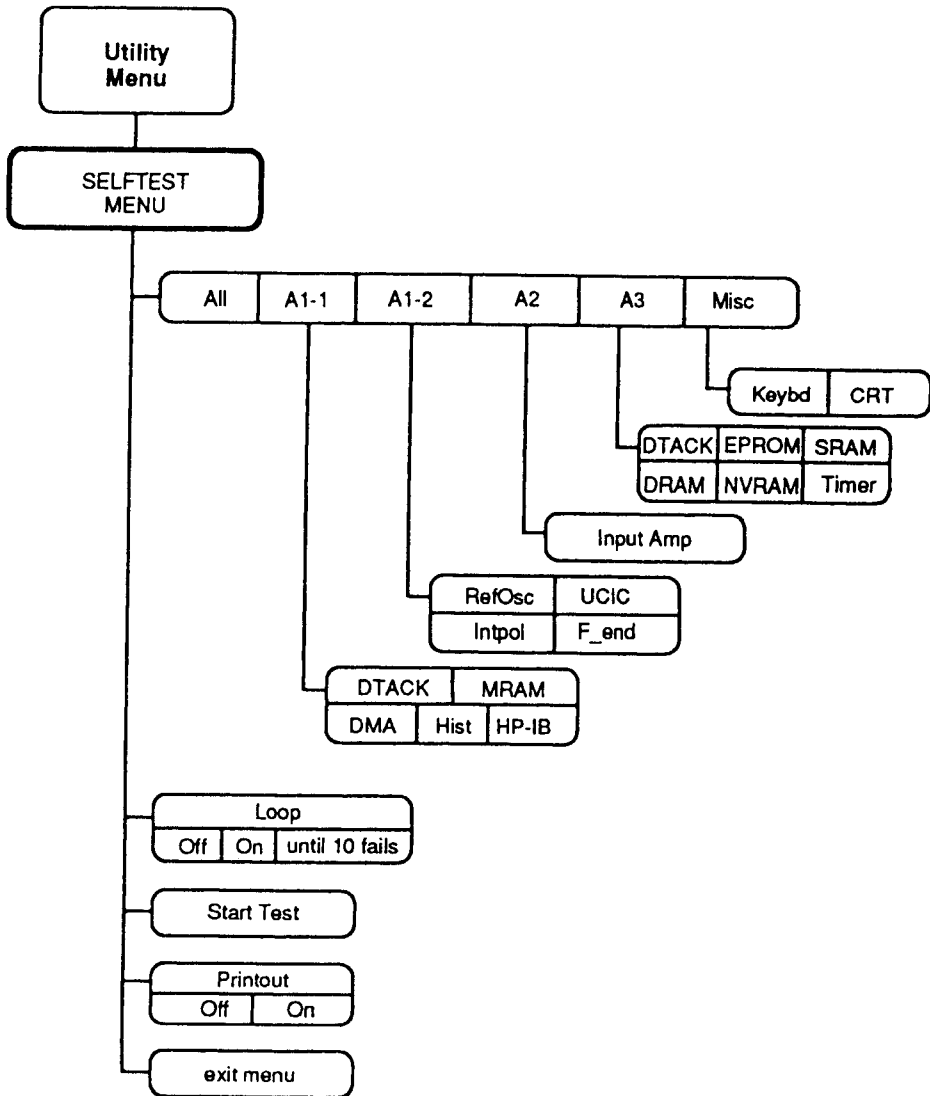

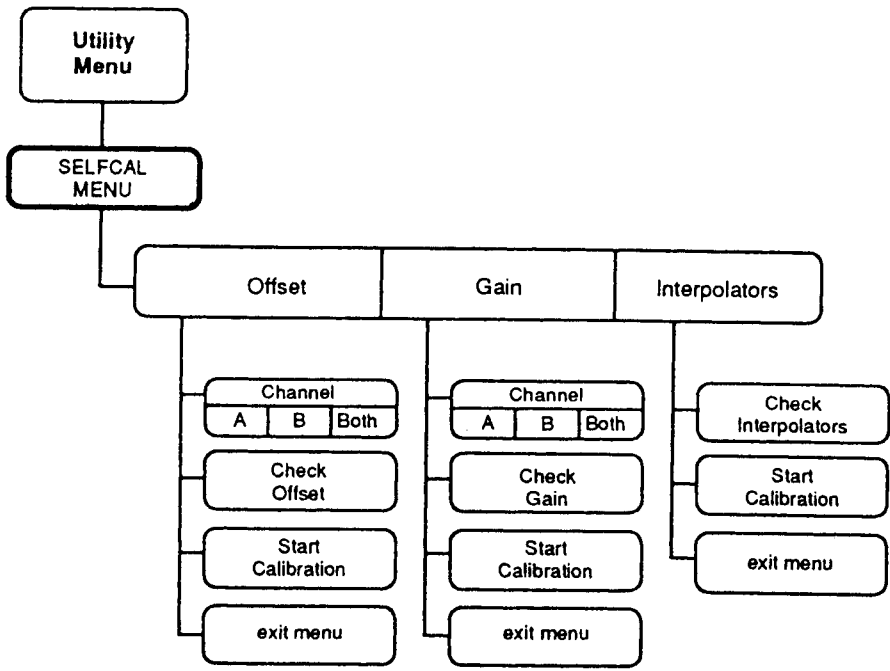

In This Chapter

The Utility Menu provides access to the self-calibration and self-test functions, as well as to the HP-IB interface set-up.

The Utility menus are the following:

HP-IB/Print menu

Self Test menu

Self Cal menu

Screen Saver

The screen saver feature can be used to help extend the expected life of the CRT and reduce the likelihood of having screen images “burned” into the screen. When screen saver is set to on, the CRT will turn off after approximately one hour with no key on the front panel pressed or no interaction over the HP-IB. Pressing any front-panel key, or sending a command from a controller over the HP-IB will cause the CRT to turn on again.

Comments

Screen Saver preset = Off

**Related Programming
Commands**

:SYSTem:SSAVer

Clicker

Clicker The clicker softkey allows you to select on or off the audible click produced each time a key is pressed.

Comments Clicker preset = On

Related Programming Commands :SYSTem:CLICker

HP-IB/Print Menu

The HP-IB menu allows you to set the Analyzer to communicate with peripheral devices over the HP-IB. This interface control includes two options:

- Talk Only mode
- Addressed mode

Comments The Talk Only or Addressed setting is not affected by Preset.

The Analyzer is set at the factory to address 12.

Talk Only Mode

Use the Talk Only mode when you want to copy the display screen to an attached printer without the intervention of a controller. Refer to the Print key description in chapter 1 for more on printing screens to a printer.

Addressed Mode

This mode allows a controlling device to selectively address the Analyzer for talking or listening. The address of the Analyzer can be set from the front panel only, while the instrument is in the addressed mode.

Comments The range of permissible addresses is 1 – 30, inclusive.

The address selection is not affected by Preset.

Form Feed

If the form feed option is on, the printer will perform a form feed at the end of a print operation. If the form feed option is off, the page will scroll up four lines when the print operation is complete.

Comments

Form Feed preset = Off

Paper Length

You can select between 11 inch or 12 inch page lengths for the auto form feed.

Comments

Paper Length preset = 11 in.

Set Up Printer

Use this softkey to initialize a connected printer, such as the HP 2225 ThinkJet printer, when switching between the 11 or 12 inch paper lengths.

Exit Menu

Pressing this softkey will return you to the Utility main menu.

Self Cal Menu

In the self cal menu you can calibrate three internal parameters:

- Offset
- Gain
- Interpolators

Comments Refer to chapter 2, "Performance Tests," of the *HP 53310A Service Manual* for more information on the self cal procedures.

Related Programming Commands :DIAGnostic:CALibration Subtree and *CAL? Common Command

Channel

Select the channel you want to check or calibrate: A, B, or Both.

Check

Read the calibration instructions on the display.

Press this softkey to run a routine that checks the current values for the selected parameter.

Start Calibration

Read the calibration instructions on the display.

Press this softkey to have the Analyzer compute and update the values for the selected parameter.

Related Programming Commands :DIAGnostic:CALibration:INPut:OFFSET
:DIAGnostic:CALibration:INPut:GAIN
:DIAGnostic:CALibration:INTerp

In Case of Failure

If the self cal procedures fail, have the adjustments and calibration procedures in chapter 3 of the *HP 53310A Service Manual* performed by qualified service personnel.

Exit Menu

Pressing this softkey will return you to the Utility main menu.

Self Test Menu

The Analyzer has been designed to perform internal diagnostics. This self test menu allows you to test the Analyzer to determine if a problem exists.

Related Programming Commands

*TST? Common Command

Select What to Test

With the top softkey on this menu, you can select the portion of the Analyzer to test. Each of the test items are listed below.

All

All portions of the Analyzer checked by the self test routines are tested.

A1-1

The A1-1 selection presents a multiple selection softkey. The options are:

- DTACK
- MRAM
- DMA
- Histogram
- HP-IB

A1-2

The A1-2 selection presents a multiple selection softkey. The options are:

- Ref Osc
- UCIC
- Interpolators
- Front End

Loop

A2 One section is tested. It is:

- Input Amplifier section

A3 The A3 selection presents a multiple selection softkey. The options are:

- DTACK
- EPROM
- SRAM
- DRAM
- NVRAM
- Timer

Miscellaneous The Misc selection presents a multiple selection softkey. The options are:

- Keyboard
- CRT

Loop This multiple selection softkey provides the following options:

- Off — The selected test will execute once and stop.
- On — The selected test will execute repeatedly. A count is displayed for both the number of times the test has executed and the number of times a failure was encountered.
- until 10 fails — The selected test will execute repeatedly until 10 failures occur. At that point, the test stops. A count is displayed for both the number of times the test has executed and the number of times a failure was encountered.

Start Test

Use this softkey to start and stop the tests. Once you press this softkey to begin a test, the softkey's label changes to STOP TEST.

Printout

When set to On, the Analyzer will output any test failure messages to a connected printer.

In Case of Failure

Should a failure occur, refer to the *HP 53310A Service Manual* for more information and the procedures to follow. The adjustments and calibration procedures in chapter 3 of the service manual should be performed by qualified service personnel.

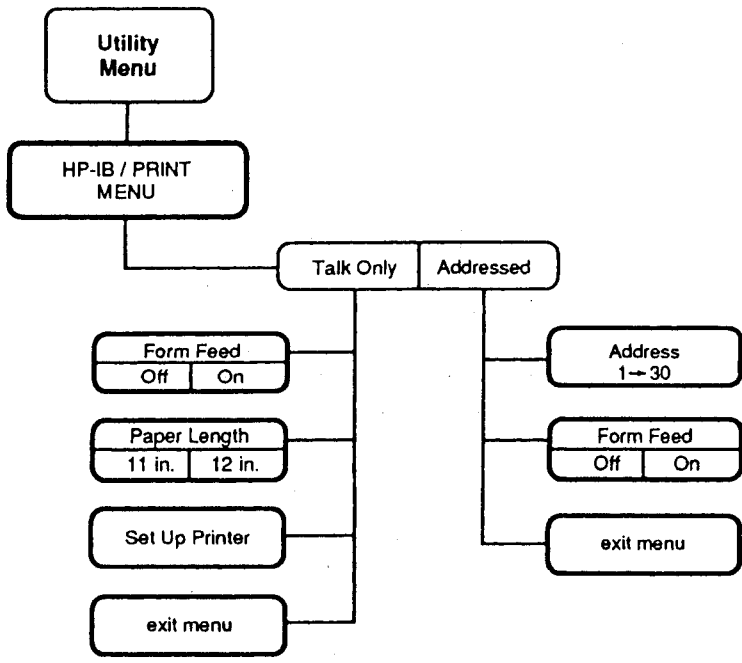

A

INSTALLATION / REAR PANEL

In This Appendix

This appendix provides the installation instructions, including unpacking, initial inspection, storage, and shipment information for the HP 53310A Modulation Domain Analyzer. This appendix also includes a description of the Analyzer's rear panel.

Unpacking and Inspection

WARNING

TO AVOID HAZARDOUS ELECTRIC SHOCK, DO NOT PERFORM ELECTRICAL TESTS WHEN THERE ARE SIGNS OF SHIPPING DAMAGE TO ANY PORTION OF THE OUTER ENCLOSURE (COVERS, PANELS, CONNECTORS, LEADS, ETC.).

Inspect the shipping container and cushioning material for damage. If damage is evident, keep the packing materials until the contents of the shipment have been checked for completeness and the instrument has been checked mechanically and electrically. If the contents are incomplete, if there is mechanical damage or defect, or if the instrument or some component fails the performance tests, notify the nearest Hewlett-Packard office. If the shipping container is damaged, or the cushioning material shows signs of stress, notify the carrier as well as the Hewlett-Packard office. Keep the shipping materials for the carrier's inspection. The HP office will arrange for repair or replacement at HP's option without waiting for a claim settlement.

**Preparation
for Use**

The following information should be reviewed before using the Analyzer for the first time.

**Operating
Temperature**

The instrument may be operated in temperatures from 0°C to +55° C (-32° to 131° F).

Bench Operation

Set the Analyzer on a flat surface where there is space behind to allow an unrestricted airflow for the fan and ventilation openings in the rear panel.

Use the tilt stands on the bottom of the Analyzer if they will provide a more comfortable angle for viewing and using the front panel.

**Power
Requirements**

The power requirements for the Analyzer are as follows:

- Voltage: 115 / 230 V ac (-25% to +25%)
- Frequency: 48 to 66 Hz
- Maximum Power: 300 VA

WARNING

THIS IS A SAFETY CLASS 1 INSTRUMENT. TO MINIMIZE SHOCK HAZARD, THE INSTRUMENT IS EQUIPPED WITH A PROTECTIVE EARTH TERMINAL. AN UNINTERRUPTIBLE SAFETY EARTH GROUND MUST BE PROVIDED FROM THE MAINS POWER SOURCE TO THE INSTRUMENT INPUT WIRING TERMINALS, POWER CORD, OR SUPPLIED POWER CORD SET. WHENEVER IT IS LIKELY THAT THE PROTECTION HAS BEEN IMPAIRED, THE INSTRUMENT MUST BE MADE INOPERATIVE AND BE SECURED AGAINST ANY UNINTENDED OPERATION.

IF THIS INSTRUMENT IS TO BE ENERGIZED VIA AN EXTERNAL AUTOTRANSFORMER FOR VOLTAGE REDUCTION, MAKE SURE THAT THE COMMON TERMINAL IS CONNECTED TO THE EARTHED POLE OF THE POWER SOURCE. FAILURE TO GROUND THE INSTRUMENT CAN RESULT IN PERSONAL INJURY. REFER TO THE PARAGRAPH ON POWER CABLES IN THIS APPENDIX.

Selecting Line Voltage

CAUTION

BEFORE PLUGGING THIS INSTRUMENT into the Mains (line) voltage, be sure the Analyzer is set to the correct line voltage for your area. The Analyzer without Option 010 has a single line voltage setting. The Analyzer with Option 010 High Stability Oven Time Base has a second line voltage setting for the oven oscillator power supply. See figures A-1 and A-4 below.

Preparation for Use

The fuse module must be in the correct position for the line voltage in your area. The fuse module is part of the power module on the rear panel of the instrument as shown in *figure A-1*. The figure shows the power modules for both the standard and Option 010 instruments.

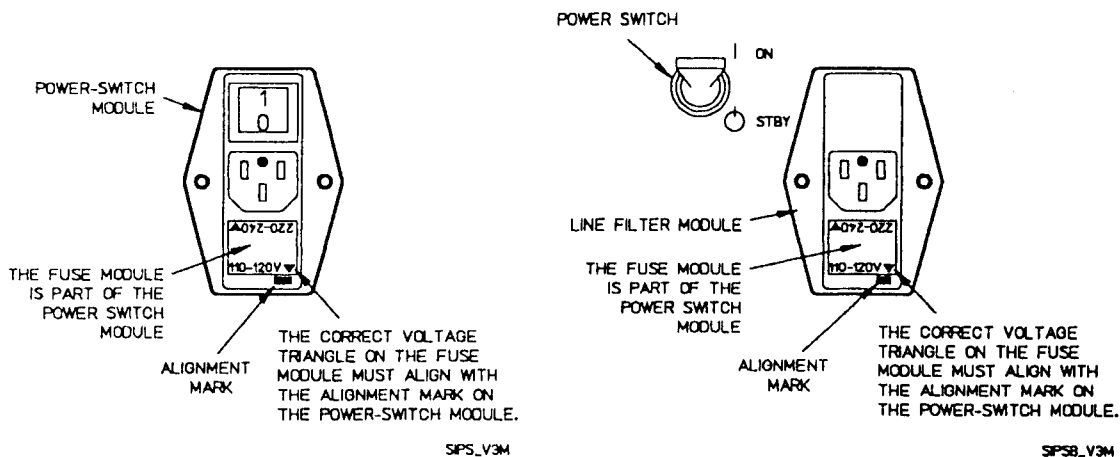

(a) Standard Instrument Power Module

b) Option 010 Instrument Power Module

(Also see *figure A-4* to make sure the line voltage setting and the fuse is correct for the Option 010 oven oscillator power supply.)

Figure A-1. HP 53310A Input Power Modules

If you need to change the line voltage selected for the Analyzer, carefully pry at the top of the fuse module with a flat-blade screwdriver (as shown in *figure A-2*) until you can grasp and pull it out with your fingers. Align the correct voltage marker with the marker on the power module as shown in *figure A-1*. Then, re-insert the fuse module into the power module.

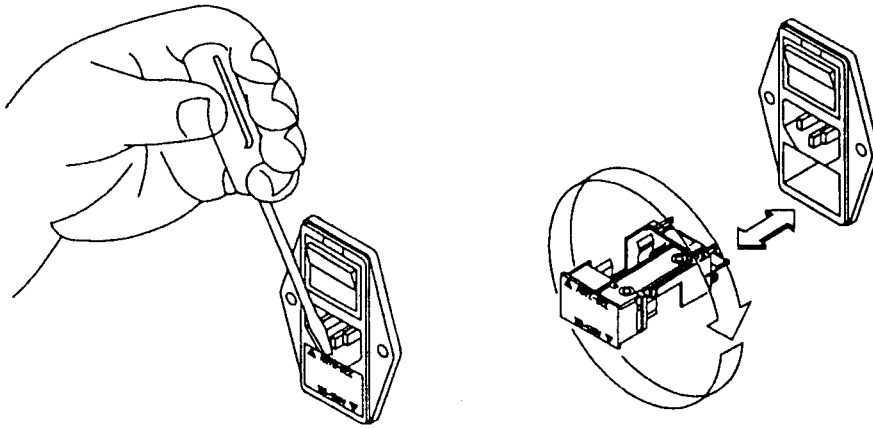

SLV_V3M

Figure A-2. Selecting Line Voltage

Checking for the Correct Fuse

If you find it necessary to check or change the fuse(s), follow the directions below for checking the standard, as well as an Option 010 instrument.

Power Module Fuses

Remove the fuse module as described under, "Selecting Line Voltage," and inspect each fuse for its amperage and voltage ratings. See *figure A-3*.

Preparation for Use

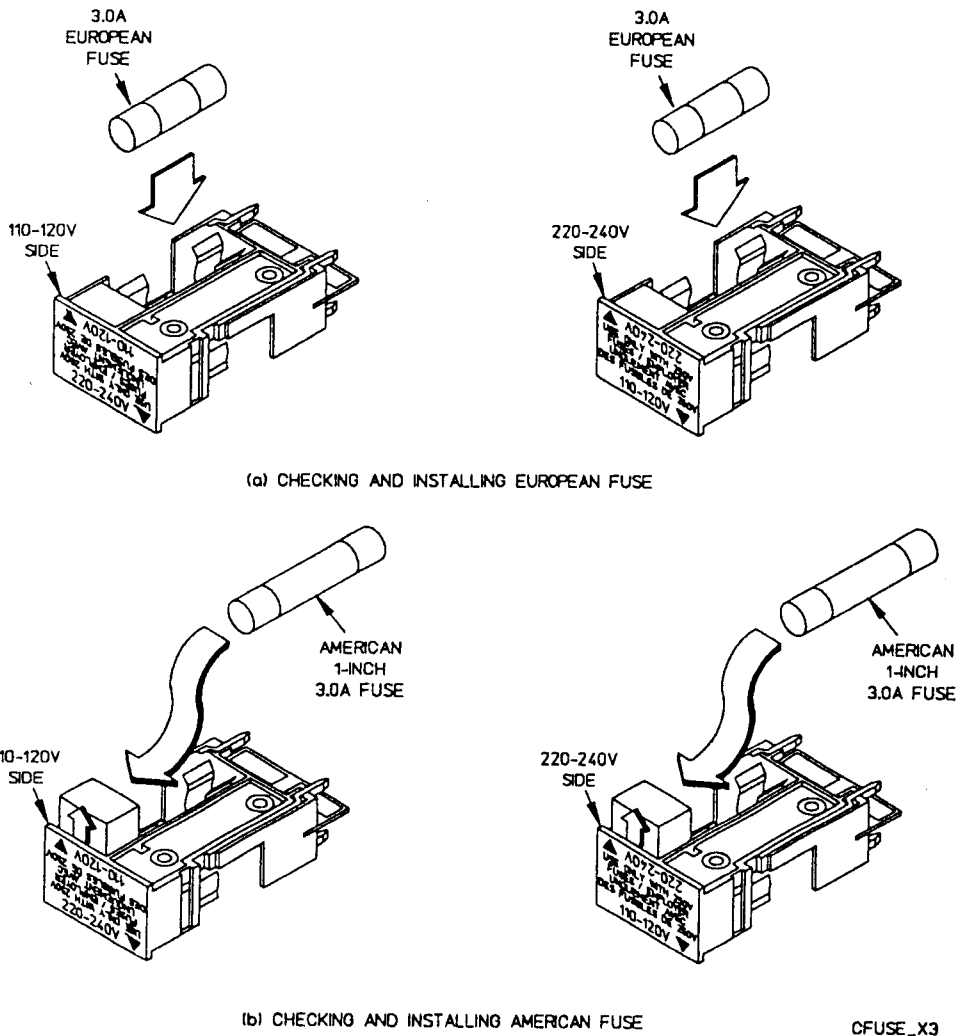

Figure A-3. Checking For The Correct Fuse

Oven Oscillator Fuse

The Analyzer with Option 010 High Stability Oven Time Base has a fuse and voltage selection for the oven oscillator power supply. *Figure A-4* shows the oven oscillator fuseholder (slotted cap) and the line voltage selector switch. Use a medium size flat-blade screwdriver to remove the fuseholder cap.

As indicated on the oven oscillator section of the rear panel (see *figure A-4*), use a 0.5A fuse for a 115-120 V line voltage source, or 0.25 A fuse for a 220-240 V line voltage source.

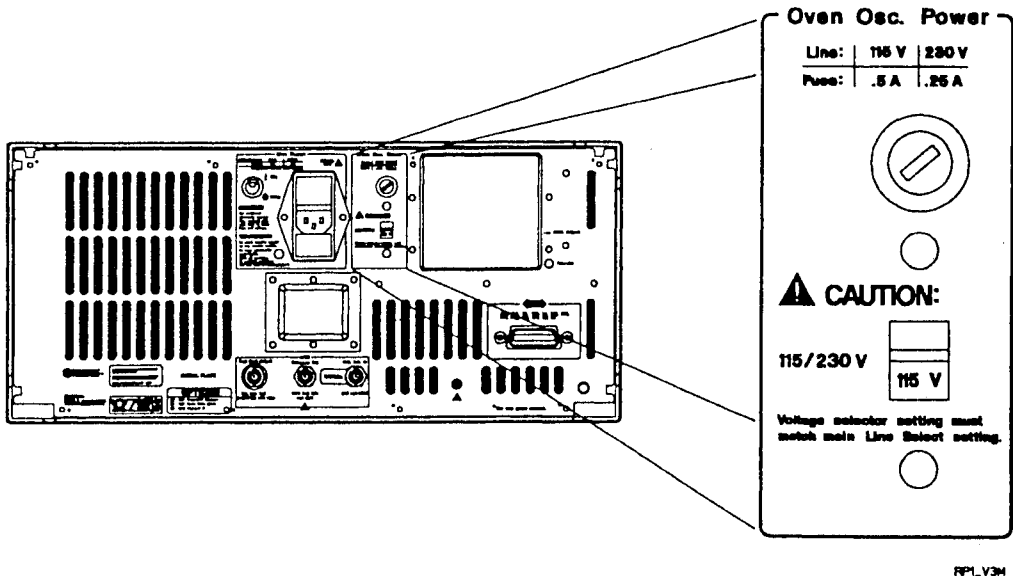

Figure A-4. Selecting Line Voltage for Option 010 Oven Oscillator Power Supply

Power Cable

This instrument is equipped with a three-wire power cable. When connected to an appropriate ac power receptacle, this cable grounds the instrument cabinet. The type of power cable shipped with each instrument depends on the country of destination. Refer to *table A-1* for the part number of the power cables and mains plugs available.

Preparation for Use

Table A-1. AC Power Cables Available







Plug Type	Cable HP Part No.	*C D	Plug Description	Cable Length (Inches)	Cable Color	For Use In Country
<p>250V</p> 	8120-1351 8120-1703	0 6	Straight **BS1363A 90°	90 90	Mint Gray Mint Gray	United Kingdom, Cyprus, Nigeria, Rhodesia, Singapore
<p>250V</p> 	8120-1369 8120-0696	0 4	Straight **NZSS198/ASC112 90°	79 87	Gray Gray	Australia, New Zealand
<p>250V</p> 	8120-1689 8120-1692	7 2	Straight **CEE7-Y11 90°	79 79	Mint Gray Mint Gray	East and West Europe, Egypt, (Unpolarized in many nations)
<p>125V</p> 	8120-1348 8120-1398 8120-1754 8120-1378 8120-1521 8120-1676 8120-4753	5 5 7 1 6 2	Straight **NEMA5-15P 90° Straight **NEMA5-15P Straight **NEMA5-15P 90° Straight **NEMA5-15P Straight **NEMA5-15P	80 80 36 80 80 30 90	Black Black Black Jade Gray Jade Gray Jade Gray Dark Gray	United States, Canada, 100V or 200V, Mexico, Philippines, Taiwan, Saudi Arabia, Japan
<p>250V</p> 	8120-2104	3	Straight **SEV1011 1959-24507 Type 12	79	Gray	Switzerland

Table A-1. AC Power Cables Available (Continued)

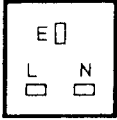
Plug Type	Cable HP Part No.	*C D	Plug Description	Cable Length (Inches)	Cable Color	For Use in Country
<p>250V</p> 	8120-0698	6	Straight **NEMA6-15P			United States, Canada
<p>220V</p> 	8120-2956 8120-2957	2 3	Straight **DHCK 107 90°	79 79	Gray Gray	Denmark
<p>220V</p> 	8120-4211 8120-4600		Straight 90°		Gray Gray	South Africa, India
<p>*CD = Check Digit (refer to Replaceable Parts in Service Manual).</p> <p>**Part number shown for plug is industry identifier for plug only. Number shown for cable is HP Part Number for complete cable including plug.</p> <p>E = Earth Ground L = Line N = Neutral</p>						

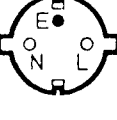
Hewlett-Packard Interface Bus (HP-IB)

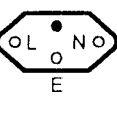
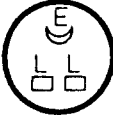
HP-IB Interconnections

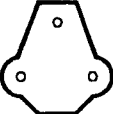
HEWLETT-PACKARD INTERFACE BUS. Interconnection data concerning the rear panel HP-IB connector is provided in *figure A-5*. This connector is compatible with the HP10833A/B/C/D HP-IB cables. The HP-IB system allows interconnection of up to 15 (including the controller) HP-IB compatible instruments. The HP-IB cables have identical "piggy-back" connectors on both ends so that several cables can be connected to a single source without special adapters or switch boxes. System components and devices may be connected in virtually any configuration desired. There must, of course, be a path from the controller to every device operating on the bus. As a practical matter, avoid stacking more than three or four cables on any one connector. If the stack gets too large, the force on the stack produces great leverage which can damage the connector mounting. Be sure each connector is firmly (finger tight) screwed in place to keep it from working loose during use.

CABLE LENGTH RESTRICTIONS. To achieve design performance with the HP-IB, proper voltage levels and timing relationship must be maintained. If the system cable is too long, the lines cannot be driven properly. Therefore, when interconnecting an HP-IB system, it is important to observe the following rules:

1. The total cable length for the system must be equal to or less than 2 meters (6.6 feet) times the total number of devices connected to the bus.
2. The total cable length for the system must be less than or equal to 20 meters (65.6 feet).
3. The total number of instruments connected to the bus must not exceed 15.

HP-IB Address Selection

The HP-IB device address of the Analyzer is selected from the front panel, on the HP-IB/Print menu (see Utility menu). The address applies to both the talk and listen functions. The selectable addresses are from 1 to 30.

The device address is retained in non-volatile memory. If the battery or memory fails, the address defaults to "12".

HP-IB Descriptions

A description of the Hewlett-Packard Interface Bus (HP-IB) is provided in the *HP53310A Programming Reference Manual*. Study of the information in the Programming Manual is necessary if you are not familiar with HP-IB concepts. Additional information concerning the design criteria and operation of the bus is available in IEEE Standard 488-1987, titled *Standard Digital Interface for Programming Instrumentation*.

Hewlett-Packard Interface Bus (HP-IB)

PIN LINE

- 1 DIO1
- 2 DIO2
- 3 DIO3
- 4 DIO4
- 13 DIO5
- 14 DIO6
- 15 DIO7
- 16 DIO8
- 5 EOI
- 17 REN
- 6 DAV
- 7 NRFD
- 8 NDAC
- 9 IFC
- 10 SRQ
- 11 ATN
- 12 SHIELD-CHASSIS GROUND
- 18 P/O TWISTED PAIR WITH PIN 6
- 19 P/O TWISTED PAIR WITH PIN 7
- 20 P/O TWISTED PAIR WITH PIN 8
- 21 P/O TWISTED PAIR WITH PIN 9
- 22 P/O TWISTED PAIR WITH PIN 10
- 23 P/O TWISTED PAIR WITH PIN 11
- 24 ISOLATED DIGITAL GROUND

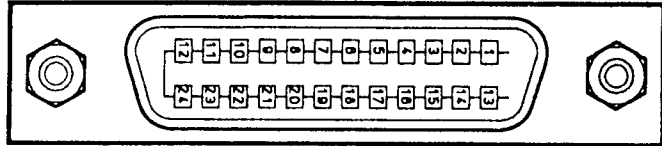

THESE PINS
ARE
INTERNALLY
GROUNDED

CAUTION

The Analyzer contains metric threaded HP-IB cable mounting studs as opposed to English threads. Metric threaded HP 10833A, B, C, or D HP-IB cable lockscrows must be used to secure the cable to the instrument. Identification of the two types of mounting studs and lockscrows is made by their color. English threaded fasteners are colored silver and metric threaded fasteners are colored black. DO NOT mate silver and black fasteners to each other or the threads of either or both will be destroyed. Metric threaded HP-IB cable lockscrow illustration and part number follow.

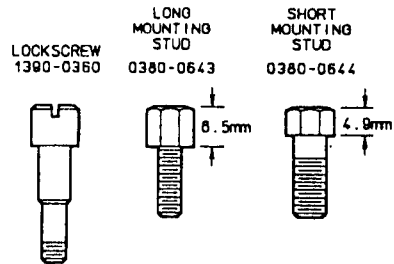

Figure A-5. Hewlett-Packard Interface Bus Connection

Logic Levels

The Hewlett-Packard Interface Bus logic levels are TTL compatible, i.e., the true (1) state is 0.0V dc to 0.4V dc and the false (0) state is +2.5V dc to +5.0V dc.

Mating Connector

HP 1251-0293; Amphenol 57-30240.

Mating Cables Available

HP 10631A, 1 metre (3.3 ft.), HP 10631B, 2 metres (6.6 ft.),
HP 10631C, 4 metres (13.2 ft.), HP 10631D, 1/2 metre (1.6 ft.).

Cabling Restrictions

1. A Hewlett-Packard Interface Bus System may contain no more than 2 metres (6.6 ft.) of connecting cable per instrument.
2. The maximum accumulative length of connecting cable for any Hewlett-Packard Interface Bus System is 20.0 metres (65.6 ft.)
3. The maximum number of instruments in one system is fifteen.

Figure A-5. Hewlett-Packard Interface Bus Connection (Continued)

Rack Mounting Kits

The available rack mount kits are:

- HP 5061-6175 Rack Mount Kit
- HP 1494-0015 Rack Mount Slide Kit

NOTE

The power switch on the Rack Mount Kit will disconnect all power to the instrument when switched off. Using the rack mount's power switch is not recommended for use with the Option 010 High Stability Oven Time Base.

The rack mounting contents and installation instructions are provided with each rack mount kit. If a kit was not ordered with the instrument, it can be ordered through your nearest HP Sales and Support Office.

Storage and Shipment

Environment

The instrument may be stored or shipped in environments within the following limits:

TEMPERATURE . . . - 40° to 70°C (- 40° to 158° F)
HUMIDITY Up to 95%
ALTITUDE 15,240 meters (50,000 feet)

The instrument should also be protected from temperature extremes which cause condensation within the instrument.

Packaging

Original Packaging

Container and materials identical to those used in factory packaging are available through Hewlett-Packard for servicing; attach a tag indicating the type of service required, return address, model number, and full serial number. Also, mark the container **FRAGILE** to ensure careful handling. In any correspondence, refer to the instrument by model number and full serial number.

Other Packaging

The following general instructions should be used for repacking with commercially available materials:

1. Wrap instrument in heavy paper or plastic. If shipping to Hewlett-Packard office or service center, attach tag indicating type of service required, return address, model number, and full serial number.
2. Use strong shipping container. A double-wall carton made of 2.4 MPa (350 psi) test material is adequate.
3. Use a layer of shock-absorbing material 70 to 100 mm (3- to 4-inch) thick around all sides of the instrument to provide firm cushioning and prevent movement inside container. Protect control panel with cardboard.
4. Seal shipping container securely.
5. Mark shipping container **FRAGILE** to ensure careful handling.
6. In any correspondence, refer to instrument by model number and full serial number.

Rear Panel

The features on the rear panel are:

- HP-IB Connector
- Test Limit Output
- Reference Out
- External Reference In
- Oscillator Adjust
- Intensity Adjust

HP-IB Connector

The HP-IB connector can be used for connecting the Analyzer to a controller, or optionally, a listen-only printer. Refer to this appendix for more information.

Test Limit Output

The Test Limit Output BNC connector provides signals to indicate status information for the following measurement modes:

- **Fast Histogram** — The output signal will go high when measurements fall outside the set measurement range of the Fast Histogram. The signal is low when measurements are within the measurement range.
- **vs. Time** — The output signal will indicate each time the value trigger condition is met following the pre-trigger delay. For a trigger on a rising value slope, the output is high when the measurement results are above the trigger value, and low when the measurement results are below the trigger value.

For a trigger on a falling value slope, the output is high when the measurement results are below the trigger value, and low when the measurement results are above the trigger value.

Comments

Operating Range: Low < 0.6 V and High > 1.5 V into 50 Ω

Reference Out The Analyzer can operate with the internal or an external frequency standard. The internal time base is 10 MHz. Option 010 provides a high stability oven time base.

The reference output is either the internal 10 MHz, or an external reference connected to the External Reference Input.

Comments Operating Range
(AC coupled) = 50 Ω : > 1 V p-p square wave
1 M Ω : > 2 V p-p square wave

The Analyzer displays "ref int" or "ref ext" on the display screen in the lower right corner.

External Reference In The external frequency standard can be 5 MHz or 10 MHz.

Comments Operating Range: 1 V p-p to 5 V p-p, into 1 k Ω

Damage Level: 10 V rms

When operating off an external reference, the Analyzer displays "ref ext" on the display screen in the lower right corner.

Oscillator Adjust The recommended calibration cycle for the time base reference in the Analyzer is 1 year; however, this interval depends on your accuracy requirements. Refer to chapter 3 of the *HP 53310A Service Manual* for more information and the procedures for adjusting the time base reference.

Intensity Adjust Once the Analyzer has been turned on, you may want to set the display intensity to a more comfortable setting. Adjust the intensity by turning the intensity control on the rear panel.

STATUS MESSAGES

In This Appendix

There are two types of messages documented in this appendix, **status** and **advisory** messages. They will appear near the top of the CRT display.

Status Messages

Status messages report the current operating state of the instrument.

acquiring data

The Fast Histogram measurement mode is in progress, and the data currently being taken is within the selected histogram boundaries.

auto triggering

The Analyzer is generating a trigger internally. This can only happen when the trigger mode is Auto. The Analyzer will generate a trigger if the specified trigger condition has not occurred within a nominal time period (approximately $1.5 \times$ sweep time).

no samples

The Fast Histogram measurement mode is ready to collect data, but none has yet occurred (either within or outside of the histogram boundaries). If Acquire Start on Ext has been selected, this message will appear when the Analyzer is ready for the external trigger to begin the acquisition. This message will also appear when an external trigger has been received, but no samples have yet been collected.

out of range

A Fast Histogram measurement is in progress, and the data currently being collected is either above or below the histogram boundaries.

Status Messages

POST failed

One of the Power On Self Tests failed. This message will only appear following an instrument power-on.

pre-trigger

The Analyzer is in the "pre-trigger" portion of the acquisition. This means that the Analyzer is attempting to collect samples to satisfy the pre-trigger condition. For example, if the trigger reference is Center, with a delay of 0 seconds, the Analyzer needs to acquire samples for 1/2 the sweep time before the pre-trigger requirement will have been met. This message will generally only be observed with longer sweep times. The Analyzer will not accept a trigger during the pre-trigger portion of the acquisition.

running

The acquisition mode is running (Run key has been pressed), and measurements are occurring.

stopped

The acquisition mode is Single, and no acquisition is in progress.

triggered

The acquisition is in progress and has been triggered. The trigger condition was either a value trigger or an external edge.

waiting for trigger

The Analyzer is waiting for the specified trigger condition to be satisfied. This message will only appear when the trigger mode is "Triggered." In this mode, the Analyzer will wait indefinitely for the user-specified trigger condition to occur.

Advisory Messages

Advisory messages consist of informational messages that report instrument actions and provide descriptive prompts to guide the user.

Autoscale FAILED

Can occur during Autoscale, Find Center, or Find Center And Span operations. The signal characteristics could not be determined. This may indicate a frequency in excess of the specified range of the selected input channel, or one consisting of partial pulses that do not satisfy the repetitive requirements for the Autoscale routine.

Calibrating interpolators... FAILED.

The offset, gain, and interpolator DACs could not be correctly adjusted. The original DAC values were not changed.

Calibrating interpolators... passed.

The offset, gain, and interpolator DACs have been adjusted.

Checking interpolator calibration... passed.

As part of the power-up initialization, the interpolators are checked. If this check had failed, a calibration procedure would have been performed.

Checking time axis

Can occur during the Autoscale operation. Indicates the usual setting of the horizontal axis (timebase) would result in averaging out the modulating signal. An attempt is being made to select a more appropriate timebase. This is most likely to occur with pulsed or "bursted" signals, such as pulsed r.f. or chirped radar pulses.

Completing current meas. Press STOP/SINGLE to abort.

Appears when Stop/Single key is pressed with the Analyzer in Run mode. The acquisition will finish, and then the Analyzer will stop.

Advisory Messages

Data is limited by memory size.

Appears when measurement memory fills before the time specified for measurement acquisition is reached. Data may cover only part of the display. Two ways to reduce memory usage are:

1. Decrease the acquisition time (Timebase menu).
2. Increase the sampling interval (Sampling menu).

Display is limited by acquired data.

This can appear when the Analyzer has not acquired enough data to span the time axis of the display. Generally, the reason for it is that a sampling condition has been selected which causes data to be taken much more rapidly than can be shown with the selected measurement time. Possible remedies are to shorten the measurement time (reduce the time/division setting) or increase the sampling interval (adjusted on the Sampling menu).

Edge counts on Channel A must be multiple of 2

Appears when measurement is frequency on channel A, with edge sampling on A selected. The message is a reminder that only even values are accepted for the edge count in this case.

Finding 50% threshold on Channel A

Can occur during Autoscale or Find 50% Threshold operations. The 50% point of the peak-to-peak voltage of the input signal will be set as the voltage threshold.

Finding 50% threshold on Channel B

Same behavior as for similar message for channel A.

Finding signal

A Find Center or Find Center And Span operation is in progress. These operations are described in chapter 3, "Vertical Menu."

Found better resolution

Can occur during Autoscale, Find Center, or Find Center And Span operations. A companion message to, "Seeking better resolution." This may indicate that some low level of modulation was found.

Frequency above selected maximum

The entire acquisition was at, or above, the selected maximum frequency value (selected on Vertical menu). To get the signal on the display, try Autoscale, Find Center, Find Center And Span, or manually adjust the vertical range.

Frequency span too large. Autoscale failed.

Can occur during Autoscale, Find Center, or Find Center And Span operations. The frequency of the input signal varied over such a wide range (typically greater than 100,000:1) that the requested operation was unable to make a valid determination of the signal characteristics. This might occur with signal bursts where the bursts occur at a low repetition rate, for example, bursts of 100 MHz occurring at a 10 Hz rate.

Frequency too low. Autoscale failed.

Can occur during Autoscale, Find Center, or Find Center And Span operations. Too few edges of the input signal occurred during the requested operation to permit a determination of the input signal characteristics. This may indicate no input signal or an incorrect setting of voltage threshold.

Frequency too low to adjust time axis

Can occur during Autoscale operation. The frequency of the input signal was too low to determine a modulation rate for use in selecting the horizontal axis (timebase).

Grid lines are 1 decade apart, referenced to top

Appears when histogram display is switched to Log with grid lines on, or if grid selected when in Log histogram. In Log histogram, the grid lines are powers of 10 (1 decade) apart, with the reference determined by the top value.

Hist mode changed from FAST to VS TIME mode

Appears when the “vs. Time” mode is selected with the Analyzer in the Fast Histogram mode. The histogram selection is switched from Fast Histogram to Histogram From vs. Time because of the fact that “vs. Time” and Fast Histogram are different measurement modes and cannot share data the way “vs. Time” and Fast Histogram From vs. Time can.

Advisory Messages

Limiting span

Can occur during Autoscale or Find Center And Span operations. The input signal frequency varies over a wide range, and the requested operation is adjusting the display to show the higher frequencies, with the lower frequencies possibly being off the bottom of the display. Signal bursts and hopping signals are examples of what will produce this message.

Little or no modulation found

Can occur during the Autoscale operation. Too little modulation was found to select the timebase based on the modulation characteristics. If measuring frequency, the timebase will be set to a fixed value. If measuring time interval, the timebase will be set based on the frequency of occurrence of the measured intervals.

Modulation rate too low to adjust time axis

Can occur during Autoscale operation. The rate of modulation was too low to be determined by the Autoscale routine for use in setting the horizontal axis (timebase).

No signal found on Chan A

Can occur during Autoscale or Find 50% Threshold operations. Indicates the 50% voltage threshold could not be found for the Channel A signal. The threshold setting is left unchanged. Because with some signals (particularly low frequencies) it is difficult to find the desired voltage threshold, the message does not mean an Autoscale operation is terminated. The autoscaling operation will continue, using the previous threshold setting, and in some instances Autoscale may successfully set the vertical and horizontal axes.

No signal found on Chan B

Same behavior as for the similar message for channel A.

Previous setup restored

A recall of register 0 has recovered the instrument state that was set prior to an Autoscale, Preset, or Recall operation.

print aborted not in talk only

Appears when Print key is pressed, but the Analyzer is in addressed mode. Correct situation by setting Analyzer to Talk Only mode (Utility menu, HP-IB Print softkey).

SAMPLING by Ext edge is no longer selectable

Appears when either Ext Edge triggering (vs. Time mode) or Ext Edge acquire start (Fast Histogram mode) is selected while sampling by Ext Edge is already selected. This indicates that sampling by external edge is no longer available.

Sampling interval may be multiple of selected value.

Can appear for frequency measurements when the sampling mode is Time. This message indicates that the selected sampling interval is below the approximate minimum sample interval of the Analyzer, and the actual sampling interval may be a multiple of the value that has been selected. See *table 9-2* for the approximate minimum sampling intervals. Some or all of the data may actually be collected at the selected interval, but this is not assured because of the variables involved in making measurements at intervals less than the specified minimum. To guarantee that a selected interval is used, increase the sampling interval until the message no longer appears.

Seeking better resolution

Can occur during Autoscale, Find Center, or Find Center And Span operations. An advisory message indicating the time for the requested operation is being extended in an attempt to obtain better resolution while measuring a signal with little, or no, apparent modulation. The occurrence of this message during an Autoscale operation may indicate that the horizontal axis will be set based on the required resolution, rather than the modulation rate.

Signal appears to drift. Try Autoscale again.

Can occur during the Autoscale operation. During the determination of the horizontal axis (timebase), the signal was found to have different frequency characteristics than those found during the setting of the vertical (frequency) axis. The horizontal axis will be left unchanged, and the vertical axis will indicate the frequency range found initially. This is sometimes caused by partial pulses or noise bursts occurring randomly on the input signal.

Span Includes Freqs Above Specification

Some part of the frequency span is above the specification limit. The Analyzer may be able to measure it, but you should be aware that it is beyond the specified measurement range.

Spurious modulation possible with this setup.

When this message appears, it is possible that an effect termed “spurious modulation” may occur. Spurious modulation appears as a noisy and distorted periodic modulation generated by the instrument, which might lead you to mistakenly believe there is modulation on your signal. The normal operation of the HP 53310A provides a resolution enhancement technique that improves the resolution of your measurements in the large majority of situations, as compared to traditional frequency counting techniques. In the situations identified by this message, this technique may not provide significant improvement over traditional frequency counting. A more detailed discussion of this effect is provided at the end of appendix C, under the heading of “Spurious Frequency Modulation”. The spurious modulation effect can be eliminated by increasing the sampling interval. This is accomplished by increasing the time/division value (if sampling is Auto with Auto Interval At Center) or increasing the Interval At Center value (if sampling is Auto with Manual Interval At Center).

TIMEBASE : Not available in FAST HIST mode

Appears when an attempt is made to access the Timebase menu while Fast Histogram is enabled. Since none of the parameters selected here relate to Fast Histogram mode, the menu is inaccessible. To get into the Timebase menu, go to “vs. Time” mode (selectable on Display or Histogram menus).

Timebase setting too fast for this frequency range

This indicates that your currently selected frequency span includes frequencies whose period exceeds the time span of the main display. You may want to select a larger time/div value.

Timebase setting too fast for sampling value

This indicates that the sampling selected may (depending on the actual frequency of your signal) result in samples spaced wider than the entire main display, even though the input is within the selected measurement range. You may want to select a larger time/div value or modify the sampling so that it occurs more frequently.

Too few intervals found. Autoscale failed.

Can occur during Autoscale, Find Center, or Find Center And Span operations. Too few time intervals occurred on the input signal during the requested operation to permit a determination of the signal characteristics. This may indicate no input signal, or an incorrect setting of voltage thresholds.

TRIGGER : Not available in FAST HIST mode

Appears when an attempt is made to access the Trigger menu while Fast Histogram is enabled. Since none of the parameters selected here relate to Fast Histogram mode, the menu is inaccessible. To get into the Trigger menu, go to "vs. Time" mode (selectable on Display or Histogram menus).

Unexpected value found by Autoscale routine

This message indicates the Autoscale, Find Center, or Find Center And Span operation has detected an unexpected numerical value. The results of the requested operation should not be considered valid.

Using Auto Sampling to find signal

Can occur during Find Center or Find Center And Span operations when measuring frequency, if the user has selected a sampling mode other than Auto. In frequency measurement mode, the Find Center and Find Center And Span operations always use auto sampling, even though the user may have selected a different sampling mode. Following the selected operation, the sampling mode will be restored to that selected by the user.

Vertical range > 7.75:1 Will clip bottom of screen

This message indicates that the input signal frequency varies over a wide range that exceeds the vertical span limit of the Analyzer. The bottom of the display will be clipped reducing the amount of the screen available for display of data. This situation can be corrected by adjusting the Interval At Center value when Auto sampling, or adjusting the number of edges when Edge sampling. Adjust the value until the message no longer appears.



SPECIFICATIONS

	<p>This appendix consists of two parts: 1) Description of the HP 53310A, and 2) Specifications and Characteristics.</p>
Description	<p>This section offers a brief description of the HP 53310A. It follows the menu structure of the product and describes its operation.</p>
Function	<p>Frequency Channel: A, B, or C (Option 030)*</p> <p>Time Interval Measurement: + TI or \pm TI Channel: A & B (Separate) or A only (Common) Start: f or \bar{f} Stop: f or \bar{f}</p>
Input	<p>Channels A and B Voltage Threshold Range Manual: +10 V to -10 V, settable in 2.5 mV steps. Auto: Find 50% Threshold Coupling: AC or DC Impedance: 1 MΩ or 50Ω Hysteresis: Min to Max, settable in ten steps</p> <p>Channel C (Option 030) Voltage Threshold: 0 volts Coupling: AC Impedance: 50Ω Hysteresis: Min</p> <p>External Arm Voltage Threshold: 0V, TTL (1.5 Volts), or ECL (-1.3 Volts).</p>

*Option 031 (Channel C) specifications are contained in the Option 031 User's Guide.

Description

Vertical/Histogram Display Range	Display measurement range is settable as Center and Span, or Minimum and Maximum. For Frequency measurements, the maximum display value can be selected no larger than eight times the minimum display value.
Timebase	Main Timebase Range Panorama Off: 1 μ s/div to 1 s/div Panorama On: 1 to 20 times the window timebase setting (Standard) 1 to 80 times the window timebase (Option 001) Window Timebase Range: 1 μ s/div to 1s/div Position: Adjustable throughout the Panorama Trigger Display Position: Left, Center, or Right Delay: Adjustable
Trigger	Mode: Auto or Triggered Triggered Edge Trigger Arming Mode: Arm Only or Time Reference Slope: \uparrow or \downarrow of External Value Trigger Source: Frequency or Time Interval measurements, depending on measurement function Range Frequency: 80% of minimum display value to 120% of maximum display value Time Interval: full measurement range Slope: \uparrow or \downarrow HF Reject: On or Off
Display	Type: "vs Time" or Histogram Frame type: Frame, Axes, Grid, or Off vs Time Acquisition Mode: Real Time or Repetitive Real Time Persistence: Single or Infinite Repetitive Averaging: On or Off Histogram Probability Scale (percent): Log or Linear

Probability Scaling: Auto or Manual
Accumulate: On or Off

Markers

Horizontal and vertical markers are available in "vs Time", and Histogram displays. Markers can be used in conjunction with automated analysis. They may also be used to delimit a portion of the measurement data for detailed analysis.

Histogram

Histogram Type: Histogram from "vs Time" or Fast Histogram
Accumulate: On or Off
Fast Histogram
Acquire Start: Auto, or External Start on \uparrow or \downarrow edge
Number of Measurements: 1 to 16 million per acquisition

Sampling Menu

Modes: Auto, Edge, Time, or Fast
Auto: Constant event sampling based on Timebase settings
Edge
Channel A or B: Every 1 to 256 events
External: Every event
Time: 400 ns - 1 second
Fast (Frequency only)

Utility

HP-IB/Print set up
Mode: Addressed or Talk Only

Clicker: On or Off

Screen Saver: On or Off

Calibration and Diagnostic routines

Autoscale

Setup parameters are automatically determined to display the dynamics of the input signal. Measurement function and input conditioning should be selected prior to pressing Autoscale.

Automated Analysis

Built-in analysis functions include: Minimum, Maximum, Peak to Peak, Mean, 1/Mean, Standard Deviation, (Modulation) Rate, 1/Rate, and Probability.

Save/Recall

Ten measurement setups can be stored and recalled.

Specifications and Characteristics

Frequency Measurements

Both warranted specifications and operating characteristics of the HP 53310A are discussed in this section. To distinguish warranted specifications from operating characteristics, *specifications are highlighted throughout in italics.*

Range

Channel A: *10 Hz to 200 MHz*
 Channel B: *10 Hz to 100 MHz*
 Channel C: *50 MHz to 2.5 GHz (Option 030)*

Maximum Measurement Rate

Fast Histogram: 1.5 MHz
 Other Modes: 1.0 MHz
 Fast Sampling: 7.5 MHz (repetitive signal only)

Resolution: *Maximum Available Measurement*

Resolution or Display Resolution, whichever is greater
 Maximum Available Measurement Resolution (Auto Sampling):

See Graph 1 for Channels A & B
See Graph 2 for Channel C (Option 030)

Graph 1

Maximum Available Frequency Resolution for Channels A & B. Larger Timebase settings and averaging will reduce the effects of random noise and improve resolution.

Additional considerations regarding resolution are discussed at the end of this appendix.

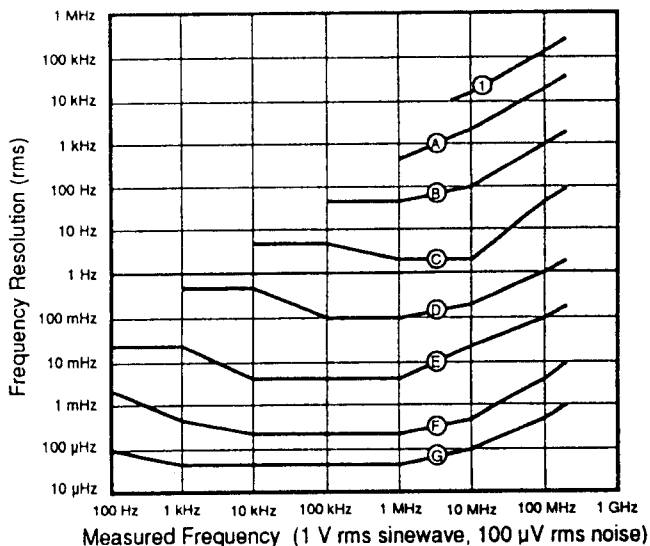

Specifications and Characteristics

Legend for Graphs 1 & 2

	Timebase Setting (Interval at Center: Auto)	Interval at Center Setting (Interval at Center: Manual)
①		125 ns [†]
Ⓐ	20 μ s/Div	1 μ s
Ⓑ	200 μ s/Div	10 μ s
Ⓒ	2 ms/Div	100 μ s
Ⓓ	20 ms/Div	1 ms
Ⓔ	200 ms/Div	10 ms
Ⓕ		100 ms
Ⓖ		0.5 s

† Fast sampling mode

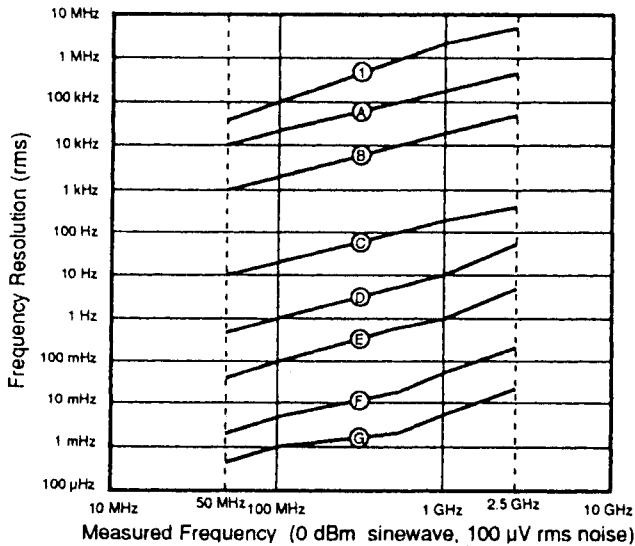

Graph 2

Maximum Available Frequency Resolution for Channel C (Option 030). Larger Timebase settings and averaging will reduce the effects of random noise and improve resolution.

Additional considerations regarding resolution are discussed at the end of this appendix.

Specifications and Characteristics

Display Resolution

vs Time, or Histogram of vs Time

Panorama Off: Display Span/256

Panorama On: Display Span/224

Fast Histogram: Display Span/450

Accuracy: $\pm (\text{Resolution} + (\text{Frequency} \times \text{Reference Error})^\dagger)$

[†] Refer to Graph 3

Graph 3
Frequency Reference Error.
Crystal aging will affect your
Frequency accuracy.

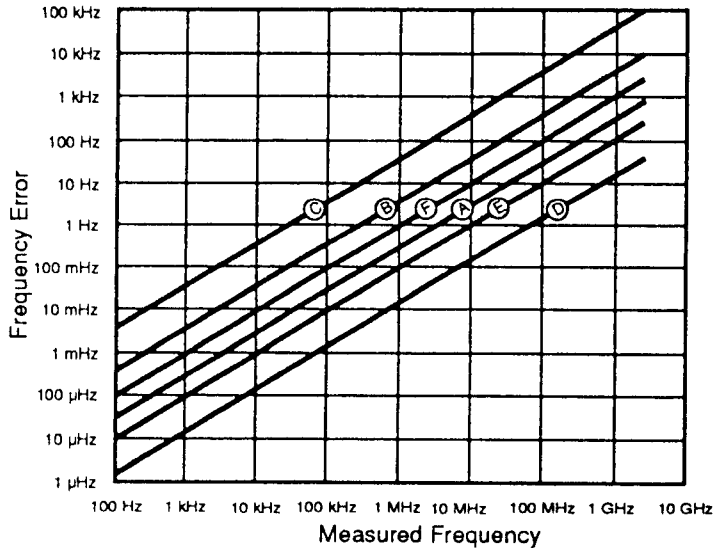

Legend for Graphs 3 & 4

Time Since Last Calibration	Standard Reference	Option 010 Reference
1 Month	(A)	(D)
1 Year	(B)	(E)
10 Years	(C)	(F)

Graph 4

*Time Interval Reference Error.
Crystal aging will affect your Time
Interval accuracy.*

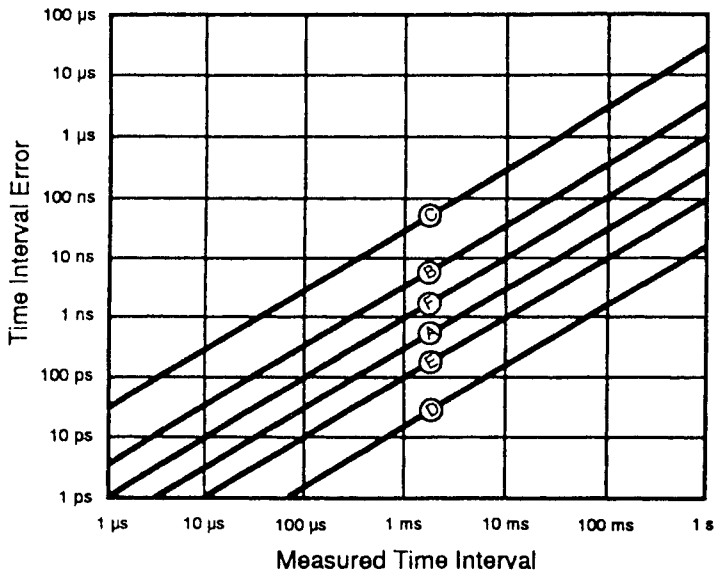

**Time Interval
Measurements**

+ Time Interval

Range: + 20 ns to + 1 second
Maximum Measurement Rate
Fast Histogram: 2.5 MHz
Other Modes: 1.25 MHz

± Time Interval

Range: -0.5 s to +0.5 second
Maximum Measurement Rate
Fast Histogram: 2.0 MHz
Other Modes: 1.25 MHz

Resolution: *Maximum Available Measurement
Resolution or Display Resolution, whichever is greater*

Maximum Available Measurement Resolution:

$$\sqrt{(200 \text{ ps rms}^*)^2 + (\text{Threshold Trigger Errors}^{\dagger\dagger})^2}$$

* 125 ps rms typical

- Note:**
- 1) Threshold Trigger Errors are usually negligible for input slew rates > 5V/ μ s.
 - 2) Through averaging, Maximum Available Measurement Resolution can be significantly improved.

Display Resolution

vs Time, or Histogram of vs Time

Panorama Off: Display Span/256

Panorama On: Display Span/224

Fast Histogram: Display Span/450

Accuracy: \pm Resolution

\pm (Time Interval \times Reference Error)^{††}

\pm Start Threshold Level Timing Error[‡]

\pm Stop Threshold Level Timing Error[‡]

\pm 1 ns Systematic Error

†† Refer to Graph 4

††† Refer to Graph 5

‡ Refer to Graph 6

Graph 5

Noise on the input signal will add error to time interval measurements. Error is associated with both start and stop edges.

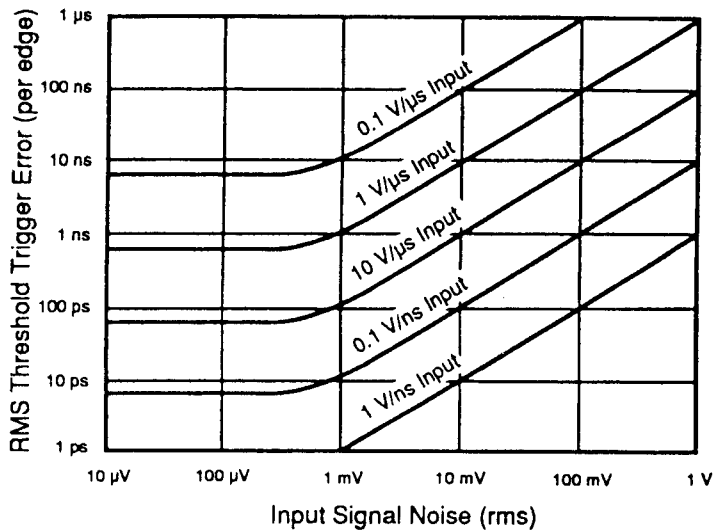

Graph 6

Voltage Threshold Level Timing Error varies with input slew rate. Error is associated with both start and stop edges.

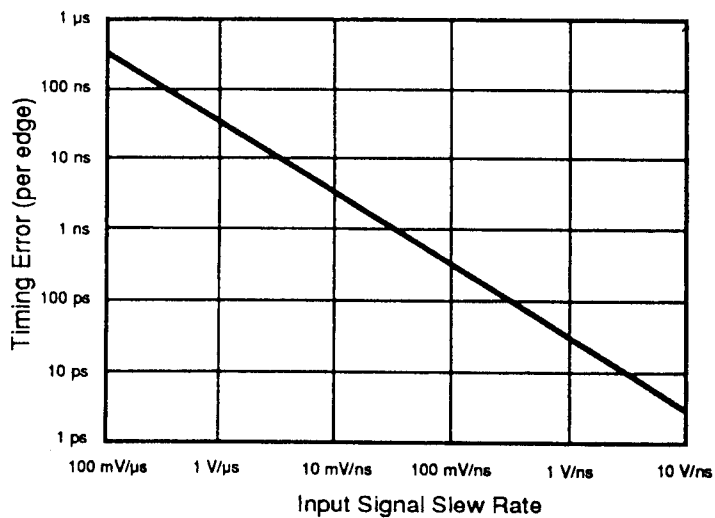

Specifications and Characteristics

Time Axis in vs Time

Resolution:

Main Timebase Setting / 45, with panorama off
Window Timebase Setting/ 45, with panorama on

Accuracy: Resolution

Note: Time aliasing can occur when time between measurements exceeds 360 divisions.

Inputs

Channel A and B

Sensitivity (minimum hysteresis):

20 mV rms sinewave to 100 MHz

(25 mV rms sinewave for Freq A from 100 MHz to 200 MHz)

Minimum Pulse Width: *5 ns at 60 mV p-p*

(2.5 ns at 75 mV p-p for Frequency A measurements above 50 MHz)

Input Amplifier Noise: 600 μ V rms

Threshold Drift: ± 3 mV after warm-up at 25°C

Voltage Threshold Accuracy: $\pm (25 \text{ mV} + 1\% \text{ of Threshold Value})$

Maximum Hysteresis: Increases the minimum input signal amplitude required by a factor of three, providing additional noise immunity.

Impedance: 50 Ω or 1 M Ω (500 k Ω in common)

AC Coupling: 100 Hz cutoff frequency

Capacitance (1 M Ω): < 20 pF (< 30 pF in common)

Dynamic Range (ac): *60 mV p-p to 5 V p-p*

Signal Operating Range (dc)

1 M Ω : ± 10 volts

50 Ω : ± 5 volts

Damage Level

1 M Ω : *40 V rms for < 5 kHz, 5 V rms for > 5 kHz*

50 Ω : *5 V rms*

Channel C (Option 030)

Sensitivity: *-25 dBm to 1.5 GHz,*

-20 dBm from >1.5 GHz to 2.0 GHz,

-15 dBm from >2.0 GHz to 2.5 GHz

Maximum Input Level: *+ 7 dBm*

Damage Level: *+ 15 dBm*

External Arm

Impedance: 1 M Ω

Delay: < 10 ns

Note: Sensitivity, Minimum Pulse Width, Signal Operating Range, and Damage Level of the External input are the same as that of Channel B.

Frequency Reference

Standard Crystal

Temperature Stability: < 8×10^{-6} , *referenced to 25°C*

Short Term Stability: $\leq 4 \times 10^{-9}$ *for 1 second average*

Aging Rate: < 3×10^{-7} /month

Option 010 High Stability Oven Reference

Temperature Stability: < 7×10^{-9} , *referenced to 25°C*

Short Term Stability: $\leq 4 \times 10^{-11}$ *for 1 second average*

Aging Rate: < 5×10^{-10} /day, < 1×10^{-7} /year

Warm-up: *Within 5×10^{-9} of final value*, 10 minutes after turn-on**.*

When:

- 1) HP 53310A is operated in a 25°C environment
- 2) Oscillator off-time** was less than 24 hours
- 3) Oscillator aging rate was < 5×10^{-10} per day prior to turnoff**

* "Final value" is defined as oscillator frequency 24 hours after turn-on. (See ** note below.)

** "Turn-off", "turn-on", and "off-time" apply to periods when power is disconnected from the HP 53310A rear panel.

Rear Panel Connectors

HP-IB

Controls: The HP 53310A provides full programmability. All instrument settings and operating modes, except specific self test routines, may be remotely programmed via HP-IB (IEEE Std 488.1-1987). The programming codes and formats comply with IEEE Standard Codes, Formats, Protocols, and Common Commands (IEEE Std 488.2-1987), and SCPI (Standard Commands for Programmable Instruments) Standard, Version 1990.0.

Specifications and Characteristics

Data Acquisition and Transfer Rate: A 450 point data record can be acquired and transferred to a computer at a rate ~ 17 times per second, as tested with an HP 9000, Series 300 controller. For this test, a 1 MHz carrier was applied to the analyzer with a Timebase setting of 40 μ s/division.

Data Transfer Rates: ~ 175 kByte/second

Interface Capabilities: SH1, AH1, T5, TE0, L4, LE0, SR1, RL1, PP0, DC1, DT1, C0, E2

Test Limit Output

The Test Limit Output will go high when measurements fall outside the display range of the Fast Histogram. In "vs Time" mode, it will indicate each time the Value Trigger condition is met following the pre-trigger delay.

Operating Range:

Low < 0.6 V and High > 1.5 V into 50 Ω

Frequency Standard Input

Frequency: 5 MHz or 10 MHz

Operating Range: 1 V p-p to 5 V p-p, into 1 k Ω

Damage Level: 10 V rms

Frequency Standard Output

Frequency: 10 MHz, or the External Reference if the Frequency Standard Input is used.

Operating Range (ac coupled)

50 Ω : > 1 V p-p square wave

1 M Ω : > 2 V p-p square wave

Power Requirements

Voltage: 115/230 V ac (-25% to + 15%)

Frequency: 48 to 66 Hz

Maximum Power: 300 VA

General

Operating Temperature: 0 to 55 $^{\circ}$ C

Weight: 10 kg net, 18 kg shipping

Dimensions: 425 mm W \times 194 mm H \times 363 mm D
(440 mm D with handle extended)

Spurious Frequency Modulation

When the HP 53310A measures the frequency of a very stable signal, such as a crystal oscillator or synthesized signal generator, for certain combinations of signal frequency and Interval At Center (as derived below), AND very small vertical span or histogram range, it may show a spurious modulation. This typically appears as a noisy and distorted periodic modulation.

If all three of the above conditions are met, the Analyzer will display the message, "Spurious modulation possible with this setup". In this unlikely situation, the Interval At Center value can be manually changed, as described below, to greatly reduce any spurious modulation.

Technical Explanation

When the HP 53310A measures frequency, very slight nonlinearities in the phase digitizing of the input signal can cause spurious mixing products from interactions between a very stable input signal, the Analyzer's internal clock and the sampling rate. In the Auto sampling mode, the Analyzer uses a digital low-pass modulation filter to greatly improve frequency resolution. The Interval At Center control on the Sampling menu controls the bandwidth of this modulation filter, as well as the measurement rate.

In the majority of situations, the spurious mixing products fall far outside the passband of the modulation filter, and therefore have no effect on the measurement. However, it is possible for a spurious mixing product to fall in the passband of the Analyzer in certain situations.

The frequency resolution specification when the spurious mixing products fall completely within the passband is:

$$\frac{\text{Time Interval Resolution} \times F}{2 \times T}$$

where Time Interval Resolution = 200 ps rms, F is the input frequency and T is the Interval At Center value on the Sampling menu. Note that even with a worst-case spurious modulation in the passband, the resolution is still better than most frequency counters.

Determining If Spurious Modulation May Occur

The Analyzer displays an advisory message if a spurious in-band modulation is possible (and if the span is narrow enough to display it), so the easiest way to determine if the effect of spurious modulation could be significant is to configure a setup and see if the message appears. However, you can perform the same analysis as the Analyzer to check for possible spurious in-band modulation using the following formulas:

$$N = \text{ceil} \left(\frac{1.2 \times F}{7 \text{ MHz}} \right)$$

$$F_{\text{sp}} = \text{minfrac} \left(\frac{N \times 200 \text{ MHz}}{F} \right) \times \frac{F}{2 \times N}$$

where F_{sp} is the frequency of the spurious modulation, F is the input frequency, N is an intermediate variable, $\text{ceil}(x)$ is the smallest integer greater than x , $\text{minfrac}(x)$ is $|x - \text{rnd}(x)|$, and $\text{rnd}(x)$ is the integer nearest to x . For the C channel, $F/64$ is used instead of F for calculating F_{sp} , and for an input signal on the A channel above 50 MHz, $F/2$ is used instead of F .

The modulation is filtered by a 2-pole digital low-pass filter, having a -3dB bandwidth of approximately:

$$\text{BW}_{-3 \text{ dB}} = \frac{1}{5 \times T}$$

where T is the Interval At Center value on the Sampling menu. As the Interval At Center value is increased (typically done by increasing the time/div value on the Timebase menu), the Analyzer's modulation bandwidth decreases, making a spurious in-band response increasingly unlikely.

If there is a spurious in-band modulation, the Interval At Center parameter on the Sampling menu can be manually changed to put a null of the digital filter at F_{sp} . The first null is at $1/(2T)$ so if T is set to $1/(2 \times F_{\text{sp}})$, the magnitude of the spurious response will be greatly reduced (typically by an order of magnitude).

**Example
Computation**

To estimate if spurious modulation will be significant, you can apply the above formulas as shown in this example (the Analyzer is always performing this analysis and will advise you when significant spurious modulation is possible). Suppose your input is at 100.1 MHz on Channel A, and the Interval At Center is 10 μ s. The worst-case resolution (if all mixing products fell in the passband) would be:

$$\frac{\text{Time Interval Resolution} \times 100.1 \text{ MHz}}{2 \times 10 \mu\text{s}} = \sim 1 \text{ kHz rms}$$

At this point, you could check this against the appropriate frequency resolution graph in this appendix. For this case, Graph 1 shows that the frequency resolution should be about 1 kHz for this example setup. Since the worst-case computation still lies within the graph specification, you might choose not to complete the computation of the actual effect of spurious modulation. For this example, the analysis will be continued.

To continue the analysis, compute N:

$$N = \text{ceil} \left(\frac{1.2 \times 50.05 \text{ MHz}}{7 \text{ MHz}} \right) = \text{ceil} (8.58) = 9$$

Note that F/2 is used (50.05 MHz) because the input signal is above 50 MHz on channel A.

Then compute the spurious modulation frequency:

$$\begin{aligned} F_{\text{sp}} &= \text{minfrac} \left(\frac{9 \times 200 \text{ MHz}}{50.05 \text{ MHz}} \right) \times \frac{50.05 \text{ MHz}}{2 \times 9} \\ &= \text{minfrac} (35.964) \times 2.78 \text{ MHz} \\ &= |35.964 - 36| \times 2.78 \text{ MHz} = \text{approximately } 100 \text{ kHz} \end{aligned}$$

Spurious Frequency Modulation

The modulation filter -3dB bandwidth for this example will be:

$$BW_{-3 \text{ dB}} = \frac{1}{5 \times 10 \mu\text{s}} = 20 \text{ kHz}$$

Since the spurious modulation frequency for this example (100 kHz) is well beyond the passband of the modulation filter (20 kHz), the effect of spurious modulation can be ignored.

GLOSSARY

Auto Trigger

The trigger mode which first attempts to display the measurement data using the specified frequency, time interval, or external edge trigger conditions, however, if these trigger conditions are not met, the Analyzer will disregard the trigger conditions and force the display of measurement data.

Dynamic Range

The AC voltage amplitude range of the input signal that the Analyzer is specified to perform measurements on.

Histogram

A bar graph whose vertical axis represents the probability in each bin and whose horizontal axis represents the range of measurement values segmented into uniform bin widths. The Analyzer performs two types of histogram processing: one from the data of the “vs. Time” display, and one directly from the raw data of the input signal (Fast Histogram).

Hysteresis

The voltage “window” centered around the voltage threshold, that an input signal must pass through to be detected by the Analyzer.

Least Significant Digit

The smallest incremental value displayed in a measurement.

Panorama Display

The smaller of the two display areas at the top of the CRT display (when Panorama is on) which allows viewing of consecutive sweeps of measurement data.

Resolution

The smallest variation of the input quantity (frequency or time interval) that the Analyzer can determine. Resolution is limited by random uncertainties and is therefore specified on an rms basis rather than a peak value.

Sample

A sample consists of two quantities: a cumulative count of voltage threshold crossings, referenced from the first threshold crossing of a sweep, and the precise time at which the threshold crossing occurred.

Sample Interval

The time between two adjacent samples of an input signal.

For frequency measurements up to the maximum measurement rate, the Analyzer will time every voltage threshold crossing. For frequency measurements greater than the maximum measurement rate, the Analyzer will time every n th voltage threshold crossing at up to the maximum measurement rate. The Analyzer specifies the sample interval at the center frequency of the CRT display, referred to as "Interval At Center."

Sampling

Sampling is the process of counting and timing the voltage threshold crossings of an input signal, and controls the rate at which this process is performed.

Sensitivity

The minimum voltage amplitude of an input signal which the Analyzer can perform a frequency measurement on.

Signal Operating Range

The voltage amplitude range of an input signal, with DC offset, that the Analyzer is specified to perform measurements on.

Sweep

A continuous series of measurements which is displayed as a single update or pass on the CRT.

Trigger

The frequency, time interval, or external edge conditions which initiate the display of measurement data.

Trigger HF Reject

A feature which controls whether high frequency modulation components from the measurement data are allowed to trigger a measurement sweep.

Voltage Threshold

The voltage level that an input signal must pass through to be detected by the Analyzer. It is also the center of the hysteresis "window."

Window Display

Activated only when Panorama is on. The Analyzer stores successive sweeps in memory and allows viewing of all sweeps through the panorama display and viewing of one sweep in the window or regular time variation display.

Index

!		D	
± TI	2-5	Delay	4-5
+TI	2-5	Delay, example	4-5
1/Mean	1-24	E	
1/rate	1-27	edge sampling, multiples of	9-10
A		Enter key	1-17
accessories available	A-2	Ext Edge, Acquire Start	8-4
accessories supplied	A-2	Ext Edge, arming mode	5-2
Accumulate	6-9, 8-5	Ext Edge, slope	5-3
Acquire Start	8-4	Ext Edge, trigger	5-2
analysis functions	1-19	External Arm	1-29
analysis range	1-20	F	
Analyze	7-4	Fast Histogram	6-1, 8-1, 8-3
Auto Center	5-3	fast sampling	9-24
Autoscale key	1-11	features, instrument	A-1
Axes	6-3, 6-7	find threshold	2-7
B		Fine key	1-18
Bottom	3-4	Frame	6-3, 6-7
C		frequency display ratio	3-7
Center	3-2	Frequency range	2-1
Channel A	1-29	fuses	A-5, A-7
Channel B	1-30	G	
Channel C	1-30	Grid	6-3, 6-7
Clear Analysis key	1-28	H	
Clear display key	1-8	HF Reject	5-4
Clear key	1-18	histogram accumulate	6-9, 8-5
Common	2-2	Histogram From vs. Time	6-1, 8-1
Connect	6-4	Histogram, Fast	8-3
coupling	2-12		
CRT	10-1		
Ctrl	4-3		

HP-IB	
address selection	A-11
description	A-11
interconnections	A-10
hysteresis	2-14

I

impedance	2-13
Input menu	2-7
input trigger lights	2-9
intensity control	A-17
Interval at Center	9-8

K

knob	1-18
------	------

L

Left	4-3
linear	6-8
Local key	1-8
log	6-8

M

manual trigger value	5-3
manuals supplied	A-1
marker tracking	7-3
markers, Freq	7-1
markers, Hist	7-2
markers, TI	7-1
markers, Time	7-1
Max	3-5
maximum	1-24
maximum sample rates	9-2
mean	1-22
measurement memory	4-1, 4-7
memory, measurement	4-1, 4-7
Min	3-5
minimum	1-25
modulation rate	1-26
Multiples of	9-10

O

operating temperature	A-2
Option 010 fuses	A-7
options available	A-2

P

Panorama	4-7
peak-to-peak	1-27
per division	3-3
power cable	A-7
power sources	A-2
Preset	1-13
Print key	1-9
printers	1-9
probability	1-22
probe, external arm	2-11

R

rate	1-26
Recall key	1-15
Reference	4-3
Reference, example	4-4
Right	4-3
Run key	1-7

S

sample rates	9-2
Save key	1-15
Separate	2-2
serial number	A-3
Shift key	1-18
Slope controls	2-4
slope, Ext Edge	5-3
slope, measurement values	5-4
Span	3-2
specifications	A-2
Spurious Frequency Modulation	C-13
standard deviation	1-20
Status key	1-15
Stop/Single key	1-7

T

Talk Only	10-2
temperature, operating	A-2
threshold, find	2-7
threshold, voltage	2-7
time aliasing	4-13
Time Interval range	2-2
time/division	4-1
timebase, window	4-10
Top	3-4
trigger	5-1
Trigger HF Reject	5-4
trigger lights	2-9
trigger value slope	5-4
trigger value, manual	5-3
triggering on unstable display	5-4

V

value slope	5-4
value trigger	5-2
voltage selection	A-4
voltage threshold	2-7
voltage threshold, external arm	2-10
vs. Time	6-2, 8-2

W

window position	4-11
window position, example	4-11
window timebase	4-10
window timebase, example	4-10
Window, time/div	4-10

Y

Y-Axis Scale	6-9
--------------------	-----

DECLARATION OF CONFORMITY

according to ISO/IEC Guide 22 and EN 45014

Manufacturer's Name: Hewlett-Packard Company

Manufacturer's Address: Santa Clara Division
5301 Stevens Creek Boulevard
Santa Clara, California 95052-8059
U.S.A.

declares, that the product

Product Name: Modulation Domain Analyzer

Model Number(s): HP 53310A

Product Options: This declaration covers all options
of the above product.

conforms to the following Product Specifications:

Safety: HD 401 (1981) / IEC 348 (1978)

EMC: EN55011 (1991) / CISPR 11 (1990) Group 1, Class A
EN50082-1 (1992) / IEC 801-2 (1984) 8 kV AD
/ IEC 801-3 (1984) 3V/m
/ IEC 801-4 (1988) 1kV

Santa Clara, California, September 30, 1992



Ian Band, QA Manager

European Contact: Your local Hewlett-Packard Sales and Service Office or Hewlett-Packard GmbH, Dept. ZQ/
Standards Europe, Herrenberger Straße 130, D-7030 Böblingen (FAX: + 49-7031-141623)